

HITACHI

Ducted split air conditioning

Cooling & Heating



Creating truly comfortable living spaces

We want to help you find the air conditioner that best suits your lifestyle. Our partnership with **temperzone** combines innovative global products with local knowledge and support to meet your needs faster, smarter and more responsibly than ever before.



WIDE AMBIENT OPERATING RANGE
-15°C IN WINTER*
46°C IN SUMMER



HIGH
COOLING & HEATING
EFFICIENCY



5 YEAR
WARRANTY



QUIET
CONTROL



ZONE
CONTROL*



WiFi APP*

* RAD models -15°C in winter / RPI models -20°C in winter.
WiFi App - RAD only.
Zone Control - RPI only.

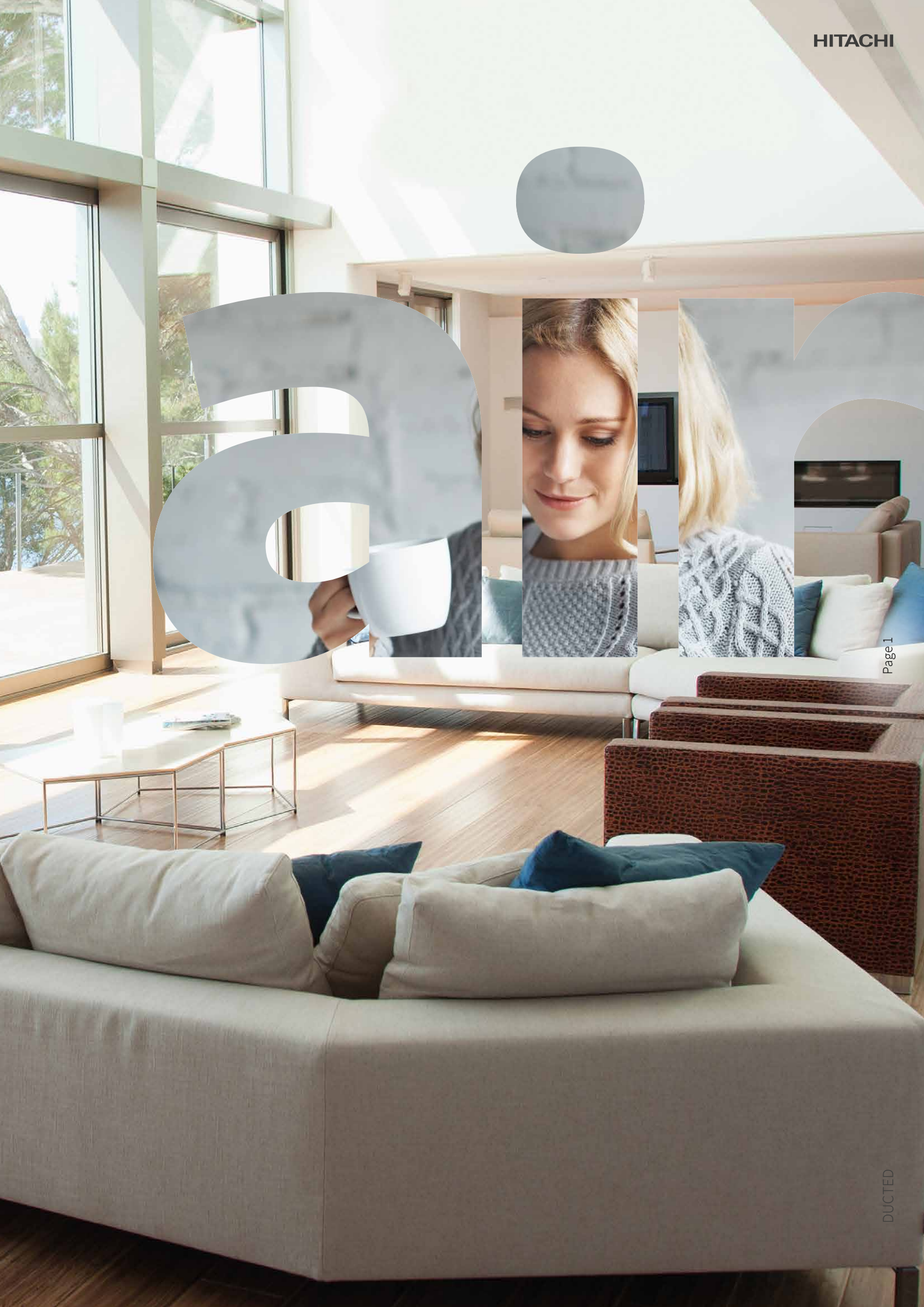

The best option for your home

Featuring a lightweight, compact design, our ducted one-to-one systems are the ideal option when installation spaces are tight and challenging.

FLEXIBILITY

Incorporating the power of DC technology, Hitachi's ducted range offers stepless inverter control and the ability to achieve superior operating efficiency.

Ranging in capacity from 5kW to 16kW, we deliver the level of comfort, convenience, and reliability that you've come to expect from Hitachi.

COMPACT DESIGN

Offering great flexibility when negotiating constrained or limited ceiling cavities, it offers a simple yet highly effective air conditioning solution.

Thanks to a unique condenser fan design, outdoor noise levels are also extremely low, making them an ideal choice for use in highly built-up areas. They also feature a unique heat exchanger fan design that increases the unit's heating capacity in cold conditions.



Advancements in technology



Key areas we have developed

COMPACT AND LIGHT

Downsizing has led to a dramatic reduction in the footprint of the range compared with previous models. This has made installation easier and improved maintenance access.

OUTDOOR UNITS

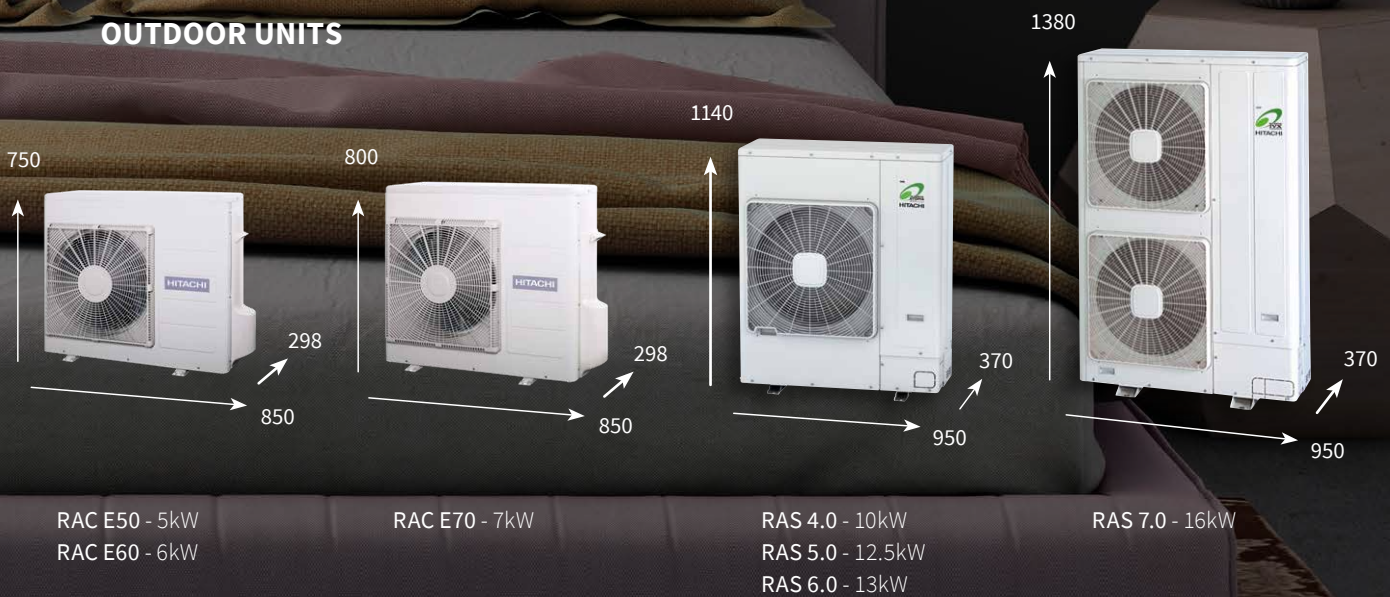



reddot winner 2021
best of the best

A NEW GENERATION OF CONTROLLER

The Advanced Colour wired controller has a 4.3" screen and uses a palette of modern colours and user-friendly pictograms to offer a fresh-looking interface.

All the latest features of Hitachi air conditioners are available with this controller.

From 0.5°C precision set temperature to advanced GentleCool anti-cold draft settings, everyone can create a pleasant atmosphere in one touch.

Stylish Wall Controller

AWARD WINNING DESIGN

Its sleek & modern design, hasn't gone unnoticed. It has now received of three awards: a Red Dot Award, an iF Design Award and it also received a 2020 European Product Design Award in the Temperature Control Systems category..

The curved front panel creates an extra touch of elegance and is convenient for users when accessing the buttons.

STYLISH REMOTE CONTROLLERS

A fully-programmable 7-day timer offers the ability to switch all units on and off automatically to conserve power when rooms are unoccupied.

The main body of the remote control switch is gently curved and the touch buttons are placed in a position that is easy to operate. You can adopt a different display colour for each operation mode.

WALL CONTROLLERS



PC-ARFG

Applicable to indoor models RPI-4.0, 5.0, 6.0 & 7.0

- Colour Display
- 24/7 time schedule
- Eco mode
- Room temperature indication
- Sleep timer
- Power consumption display
- Backlight display



SPX-WKT3

Applicable to indoor models RAD-E50, 60, 70

- 24/7 time schedule
- Eco mode
- Room temperature indication
- Sleep timer
- Power consumption display
- Backlight display

Already highly efficient, Hitachi Premium Inverter models offer **two additional ways** to configure systems to achieve even greater energy savings.

SELF-DEMAND CONTROL

Power consumption levels (as a percentage of the maximum) can be selected in advance. Following an external command during operation, the system will automatically detect the amount of power being used and limit itself to the predetermined amount during peak power usage periods.

WAVE MODE

When activated by an external command, this function cycles the system between full-power and a pre-selected reduced power setting every 10 to 20-minutes until the command is cancelled. Wave Mode results in lower average power usage and cost savings.

Applicable to RPI models

INTERNAL DRAIN PUMP

31cm Drain pump pressure lift.
RAD-E50, 60 and 70 only.



MODEL DIMENSIONS



RAD-E50 - 5kW
 RAD-E60 - 6kW
 RAD-E70 - 7kW

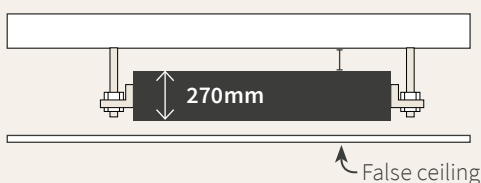

RPI 4.0 - 10kW
 RPI 5.0 - 12.5kW
 RPI 6.0 - 13kW

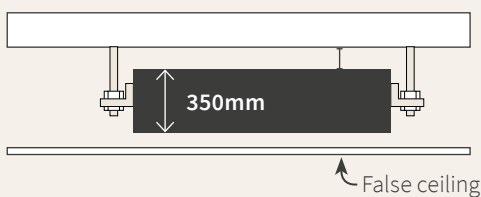

RPI 7.0 - 16kW

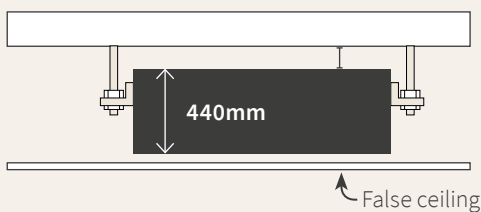

QUIET OPERATION - SUPER HIGH-STREAM FAN

Advancements in the blade design and optimisation of the inlet and outlet angles have led to an increase in efficiency while still maintaining low operating noise levels.

DC INVERTER TECHNOLOGY

A DC compressor offers improved performance during periods of extended operation. It also features a split rotor with displaced electrical poles, enabling the suppression of electromagnetic noise. Low-speed performance characteristics have also been improved, leading to significant reductions in annual running costs.

DUCTED SYSTEM

Can be combined with ducting grilles and accessories to provide superior filtration and effective clean air distribution.

KEY FEATURES

1. Space Saving Design

With a height of 270mm the RAD-E50, 60 and 70 can be installed in almost any application including homes, apartments or commercial buildings.

2. Easy Installation & Maintenance

Separable design unit for easier installation in limited roof space (RPI-4.0-6.0FSN2SQ).

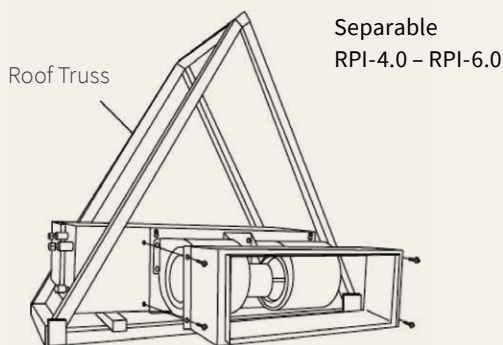

3. Quiet Operation

The well-balanced centrifugal fan provides quiet and efficient operation.

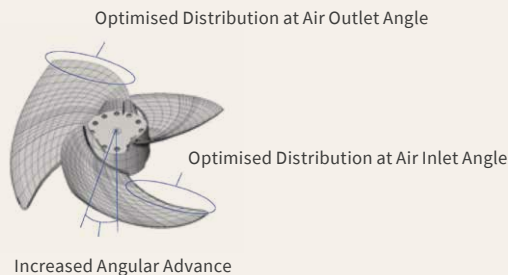



Advanced Hitachi Zone Control

Hitachi's innovative Zone Controller paired with Hitachi's quality Ducted system, offers you the most comfortable air conditioning solution for your home. Up to 8 zones can be easily individually controlled, allowing you to condition only those rooms that need heating or cooling.

IMPROVED ENERGY EFFICIENCY & PERFORMANCE

By selectively heating or cooling parts of your home that are actively being used, you can save significantly on monthly energy consumption and expenses. In return, helping you save money.

BETTER COMFORT

With the ability to open or close dampers individually, you control the air flow into individual zones, allowing greater control over the temperature and climate throughout your home during different times of the day.

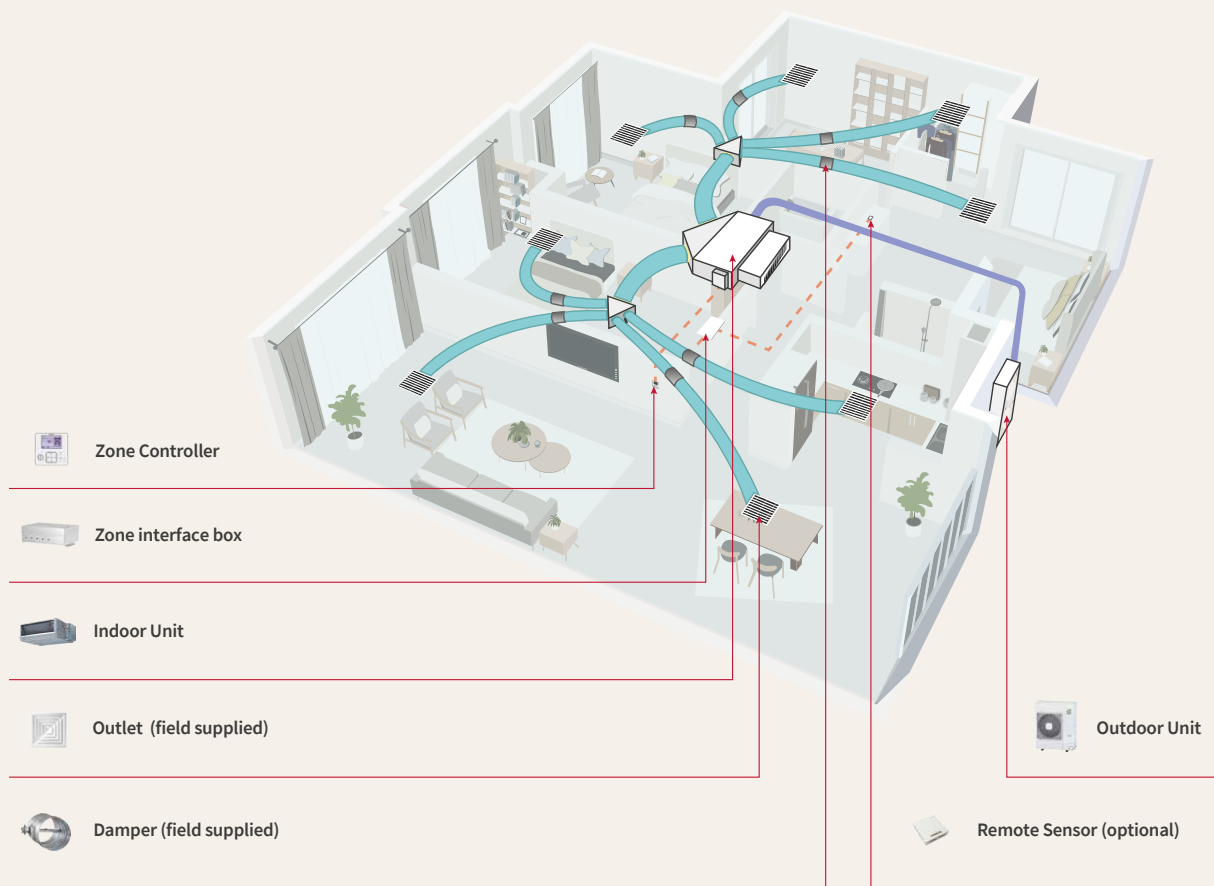

LARGE LCD SCREEN WITH BACKLIT DISPLAY

Large backlit LCD screen on the zone controller enables you to easily view individual zone status and controller functions.

ZONE NAME REGISTRATION

Each zone can be configured with a personalised name, making it easier to identify zones.

EFFORTLESS ZONE OPERATION

The zone controller has been designed with the user in mind, offering easy operation.

You can **easily switch ON or OFF** each ZONE or switch ALL zone ON or OFF simultaneously.

POWER CONSUMPTION DISPLAY

The zone controller enables you to monitor your air conditioner's power usage for a day, week or year. Power consumption information can be displayed as a graph or table.

ON / OFF CONTROL FOR UP TO 8 ZONES

Up to 8 dampers can be connected to the zoning system. Each damper can be opened and closed freely.

WEEKLY TIME CLOCK

The intuitive Hitachi Zone Controller allows you to **set up to FIVE operation schedules per day** for the week, giving you control of not only when you would like your unit to operate, but select at what comfort temperature you wish the unit to operate at.

Each of these schedules can be assigned to individual zones, allowing automated operation in each zone.

INTELLIGENT AIR-FLOW CONTROL

Selecting **Automatic fan speed** mode will allow the system to determine the optimal fan speed for the number of zones and outlets in operation, taking into account the amount of cooling or heating power needed to maintain comfort conditions.

Combining this feature along with weekly time clock schedules, not only allows set-and-forget operation, but also saves on running costs, increases comfort levels and minimises noise.



Premium iZone control at the touch of a button

Intelligent design inside and beautiful design outside, Premium zone control offers you total temperature and airflow control of your ducted system at the touch of a button.

Premium Control Option

* Entire zone system not applicable on RAD-E50, 60, 70 models.



Optional WiFi app



Local room controller options*



PREMIUM ZONE CONTROL

You can design your control system just the way you like. From a layout consisting of WiFi sensors or wired controllers in each room linked to a centralised touch screen controller to touch screen controllers in each individual room - the choice is yours.

TOUCH SCREEN CONTROLLER

Colour touch screen controller, can add additional touch pads.

WIFI / 4G ACCESS

Standard WiFi / 4G access and control suits:

- IOS
- Android
- Windows
- Smartphones and Tablets.

ZONE SENSORS

Max 14 Zones available using WiFi Zone sensor.

Optional wired iSense Zone Sensor Available

- Has built in Motion Detector
- Can close a zone off if motion not detected
- Can adjust zone temperature setting from the zone controller

ZONE CONTROL

- Individual temperature control for each zone.
- Set airflow for each zone.
- Personalise zone names.
- Set up favourite zones to suit your lifestyle.
- Set up an operating schedule for individual zones to suit your lifestyle.
- Maintains your personal settings in the event of a power failure. Memory is kept via backup.
- Auto restart on resumption of power after a power failure.

Optional Accessories



CARD KEY 'ON' AND 'OFF' FUNCTION

Switches the unit on or off via a remote device such as a hotel room card key. Save energy by switching the unit off when the room is unoccupied.



RUN AND ALARM SIGNAL

Signal indicates when a unit is running, or if the unit has stopped due to an internal fault. This is beneficial for projects where multiple units have been installed.



DEMAND RESPONSE MODULE (DRED)

Optional DRM module for instances where local requirements specify DRED compatibility.

airCloud Home

Optional Accessory, only applicable for RAD E50, E60 & E70 models.



Download today



www.aircloudhome.com

A smarter way to control your air conditioner. Anytime, anywhere.

CONTROL FROM ANYWHERE

Making sure your home is at the perfect temperature for when you arrive has never been easier. Hitachi airCloud Home allows you to remotely monitor and control your system from a single app through your smartphone.

CONTROL WITH YOUR VOICE

airCloud Home is fully compatible with Amazon Alexa and Google Assistant, enabling you to control your air conditioner hands-free.

SMART FENCE

Connect your air conditioner to your location and automatically stop and start your AC as you leave and return home.

AIRCLOUD FEATURES

- On / Off Operation
- ALL Units OFF
- Operation Mode Selectable
- Temperature Adjustment
- Smart Speaker (Google Assistant & Amazon Alexa)
- Smart Fence
- Weekly Scheduling
- On / Off Timer
- Adjustable Louvre
- Fan Speed
- Free firmware updates to latest features
- Unlimited units can be controlled through one app
- Account Management
 - Access for up to 20 users
 - Set up user permissions
- Customer Support
- Personalisation - Indoor unit naming
- Smart Notifications



Features and options comparison table

| | RAD E50 - E70 | RPI 4.0 - 7.0 |
|--|----------------------|----------------------|
| Nominal Cooling Capacities | 5, 6, 7kW | 10, 12.5, 13, 16kW |
| Eco mode function | ● | ● |
| Sleep mode | ● | ● |
| Room temperature display | ● | ● |
| Ultra low standby power | ● | ● |
| Auto restart function if set on outdoor unit | ● | ● |
| Anti corrosion paint - outdoor unit | ● | ● |
| 12hr timer control | ● | ● |
| 24/7 time clock function | ● | ● |
| Power consumption display | ● | ● |
| PC-ARFG wired controller | - | ● |
| 4 speed indoor fan | ● | - |
| SPX-WKT3 wired controller | ● | - |
| Remote key card input | ■ | ■ |
| DRED Demand response module | ■ | ● |
| Run and Alarm signal | ■ | ■ |
| Hitachi Zone Controller | - | ■ |
| Premium iZone control (with WiFi) | - | ■ |
| airCloud Home WiFi Control | ■ | - |

- STANDARD
- OPTIONAL
- NOT AVAILABLE



—
Technical specifications

Ducted - Technical Data

MODEL

| | RAD-E50YHA | RAD-E60YHA | RAD-E70YHA |
|---|----------------------------|----------------------------|----------------------------|
| Indoor | RAD-E50YHA | RAD-E60YHA | RAD-E70YHA |
| Outdoor | RAC-E50YHA | RAC-E60YHA | RAC-E70YHA |
| Capacity (kW) | | | |
| Cooling Capacity | 5.0 | 6.0 | 7.0 |
| Cooling Capacity Range | 1.2 - 5.8 | 1.2 - 6.5 | 1.5 - 8.0 |
| Heating Capacity | 6.0 | 7.0 | 8.0 |
| Heating Capacity Range | 1.2 - 6.8 | 1.2 - 8.0 | 1.5 - 8.5 |
| Energy Efficiency | | | |
| EER / AEER | 3.82 / 3.80 | 3.54 / 3.52 | 3.34 / 3.32 |
| COP / ACOP | 3.90 / 3.87 | 3.71 / 3.69 | 3.40 / 3.39 |
| Air Flow | | | |
| Air Flow l/s (Hi / Med / Low / Super low) | 300 / 250 / 200 / 170 | 300 / 250 / 200 / 170 | 415 / 325 / 200 / 170 |
| External Static Pa | 50 ~ 160 | 50 ~ 160 | 50 ~ 160 |
| Dimensions | | | |
| Indoor Unit: (H x W x D mm) | 270 x 900 x 720 | 270 x 900 x 720 | 270 x 900 x 720 |
| Outdoor: (H x W x D mm) | 750 x 850 x 298 | 750 x 850 x 298 | 800 x 850 x 298 |
| Indoor Unit Separable | No | No | No |
| Weights: Indoor kg / Outdoor kg | 35 / 50 | 35 / 50 | 35 / 52 |
| Sound Pressure Level (dB(a)) | | | |
| Indoor Unit (Hi / Med / Low / Super low) cooling | 39 / 35 / 32 / 29 | 39 / 35 / 32 / 29 | 39 / 35 / 32 / 29 |
| Outdoor Unit (Cool / Heat / Night) | 50 / 53 / - | 50 / 53 / - | 51 / 53 / - |
| Working Range (°C db) | | | |
| Cooling | -10° / 46°C | | |
| Heating | -15° / 21°C | | |
| Piping | | | |
| Pipe Connection Sizes Liquid Ømm / Gas Ømm | 6.35 / 12.70 (1/4" / 1/2") | 6.35 / 12.70 (1/4" / 1/2") | 6.35 / 15.88 (1/4" / 5/8") |
| Max Pipe Length (m) | 30 | 30 | 30 |
| Max Pre Charged Length (m) | 30 | 30 | 30 |
| Max Pipe Lift (m) (Outdoor Above / Outdoor Below) | - / 20 | | |
| Refrigeration Connections (Indoor / Outdoor) | Flare Nut / Flare Nut | | |
| Air Spigot / Drain Dimensions | | | |
| Supply Air Spigot (W x H mm) | 805 x 222 | 805 x 222 | 805 x 222 |
| Return Air Spigot (W x H mm) | 815 x 221 | 815 x 221 | 815 x 221 |
| Drain dimensions | Ø32 | Ø32 | Ø32 |
| Electrical | | | |
| Power Supply | AC 1 Ph 220 - 240V 50Hz | | |
| Outdoor Unit Max Current | 12 | 14 | 16 |
| Recommend fuse size | 20A | 20A | 20A |
| Refrigerant | | | |
| | R32 | | |

NOTES:

The cooling and heating capacity is the combined capacity of the Hitachi standard split system, and is based on the AS NZS 3823.1.2-2012. Cooling Operation Conditions: Indoor Air Inlet Temperature: 27°C DB, 19.0°C WB; Outdoor Air Inlet Temperature: 35°C DB. Heating Operation Conditions: Indoor Air Inlet Temperature: 20°C DB; Outdoor Air Inlet Temperature:

| RPI-4.0FSN2SQ RAS-4HVNC1 | RPI-5.0FSN2SQ RAS-5HVNC1 | RPI-6.0FSN2SQ RAS-6HVNC1 | RPI-7.0FSN2SQ RAS-7HVRNM2 |
|---|--|--|--|
| 10.0 4.5 - 11.2 11.2 5.0 - 14.0 | 12.5 5.7 - 14.0 14.0 5.0 - 18.0 | 13.0 6.0 - 16.0 16.0 5.0 - 20.0 | 16.0 6.0 - 18.0 18.0 5.0 - 20.0 |
| 3.63 / 3.46 4.26 / 4.02 | 3.18 / 3.01 4.05 / 3.78 | 3.11 / 2.96 3.90 / 3.68 | 3.52 / 3.35 3.91 / 3.71 |
| 600 / 550 / 416 / - 150 (max) | 783 / 716 / 566 / - 150 (max) | 933 / 833 / 666 / - 135 (max) | 1083 / 950 / 766 / - 150 (max) |
| 350 x 1076 x 800 1140 x 950 x 370 Yes 57 / 79 | 350 x 1300 x 800 1140 x 950 x 370 Yes 61 / 89 | 350 x 1300 x 800 1140 x 950 x 370 Yes 63 / 89 | 440 x 1430 x 550 1380 x 950 x 370 No 75 / 104 |
| 48 / 45 / 41 / - 52 / 54 / 50 | 49 / 46 / 43 / - 52 / 54 / 50 | 53 / 49 / 45 / - 55 / 57 / 53 | 51 / 47 / 42 / - 49 / 53 / 46 |
| <p>..... -5° / 46°C→</p> <p>..... -20° / 24°C→</p> | | | |
| 9.52 / 15.88 (3/8" / 5/8") 70 30 | 9.52 / 15.88 (3/8" / 5/8") 75 30 | 9.52 / 15.88 (3/8" / 5/8") 75 30 | 9.52 / 15.88 (3/8" / 5/8") 75 30 |
| <p>..... 30 / 20→</p> <p>..... Flare Nut / Flare Nut→</p> | | | |
| 980 x 220 813 x 306 Ø25 | 1205 x 220 813 x 306 Ø25 | 1205 x 220 935 x 306 Ø25 | 830 x 300 1288 x 402 Ø25 |
| <p>..... AC 1 Ph 220 - 240V 50Hz→</p> | | | |
| 26 - | 26 - | 26 - | 32 - |
| <p>..... R410A→</p> | | | |

7°C DB, 6°C WB. Published capacities based on Piping Length: 7.5 metres. The sound pressure level is based on following conditions: 1.5 metres beneath the unit with discharge duct (2.0m) and return duct (1.0m). Outdoor Units: 1 metre from the unit service cover surface, and 1.5 metres from floor level. Voltage of the power source for the indoor fan motor is 220V. In case of the power

source of 240V, the sound pressure level increases by about 1 or 2dB. The above data was measured in an anechoic chamber so that reflected sound should be taken into consideration in the field.



GLOW CITY

**352 Morphett Road
Warradale SA 5046
8397 6100**

GLOW SOUTH COAST

**16 Wright Road
Goolwa SA 5214
8554 2860**

info@glowhce.com.au | glowhce.com.au

temperzone Australia Pty Ltd

ENQUIRIES

sales@temperzone.com.au

AUSTRALIA

Sydney: (02) 8822 5700
Melbourne: (03) 8769 7600
Brisbane: (07) 3308 8333
Adelaide: (08) 8115 2111

DISTRIBUTORS

Newcastle: (02) 4962 1155
Perth: (08) 6399 5900
Launceston: (03) 6331 4209

NEW ZEALAND

Auckland: (09) 279 5250
Wellington: (04) 569 3262
Christchurch: (03) 379 3216



WARRANTY

Must be maintained in accordance with maintenance recommendations.

hitachiaircon.com.au

hitachiaircon.co.nz



The specifications of this catalogue may change without prior notice to allow Hitachi Cooling & Heating to incorporate the latest innovations for its customers. The information contained in this catalogue is merely informative. Hitachi Cooling & Heating declines any responsibility in the broadest sense, for damage, direct or indirect, arising from the use and / or interpretation of the recommendations in this catalogue.