

# WELCOME TO ESKIMO

Heating products designed and built in the UK to the best of British standards.

Offering stunning and beautifully engineered heating alternatives designed for a climate where heating is a serious business.

We are designers and engineers dedicated to saving the world from ugly and impractical radiators. We bring a much-needed injection of design excellence into the world of heating. Whether the emphasis is on blending into a scheme or creating impact, our forms and finishes will fit beautifully into your vision with our collection of both hydronic and electric models.

All our products are designed and developed with the same key principles of clean lines, meticulous engineering and total practicality, coupled with stunning finishes that satisfy your aesthetic needs. We have hidden valve options that offer monolithic beauty and we're the people who designed and developed Hinge & Bracket, the first accessible hidden thermostatic valve system. But no one likes a show off, so we'll get back to the point.

We believe passionately that a radiator's primary function is to provide as much heat from as small a space as possible, which is why our radiators have the highest heat outputs of any high end radiators in the world. We know that some of you will choose us for our looks alone, and why not, we are pretty tasty? But we think we're like the contestant at a beauty pageant with a double first in physics. There's so much more to us than our perfect proportions. And we believe in world peace.

In our brochure you'll find plenty of product shots, size and price lists, some technical information and a bit of practical help. Our website is constantly updated with the latest, most detailed information. So if you're in a hurry or need to know where to buy, just go to [www.eskimoheat.com.au](http://www.eskimoheat.com.au). You can call us any time too, on: 1300 544 719

ESKIMO – LOVE MAKING HEAT

# ESKIMO BROCHURE ISSUE 7, AU/NZ EDITION

## 4

**RON / LEGGY RON  
(HYDRONIC HEATING)**  
NEW special finishes,  
sublimation prints.

**Wall mounted / Floor mounted**  
Modular aluminium high output radiator:  
allowing you to add as many sections as you  
need from 1 to 50.

## 8

**RON TOWEL RAILS**

The matching elliptical towel rail is  
proportionately matched to the elliptical  
sections of the radiator.

## 10

**OUTLINE  
(HYDRONIC HEATING  
OR ELECTRIC)**

**Wall mounted.**  
Towel rails can be applied.  
The original flat panel radiator  
design for lovers of clean lines.  
Bespoke sizes available for water models.  
Hinge & Bracket hidden valves available.

The Outline radiator  
collection includes the  
following finishes:

**NEW CONCRETE 2017 10**

Real concrete veneer, beautifully finished,  
incredibly tactile and selected for  
contemporary living.

**NEW MARBLES 2017 12-13**

Real stone veneers, beautifully finished,  
incredibly tactile and selected for  
contemporary living.

## 14-17

**ELECTRIC OUTLINE  
RADIATORS  
& ACCOMPANYING  
CONTROLS**

For all flat panel Outline electric radiators.  
In any of the Outline finishes.

**WOODY 18-21**

**NEW eco Bamboo  
veneer.**

Combining the unique aesthetic properties  
of wood or bamboo, with the thermal  
performance of aluminium.

**GONG 22-27**

Beautifully patinated copper, brass and steel  
applied to Eskimo's super-powerful radiators.

**RUSTY 26**

An exclusive steel finish, hand patinated, to  
create a stunning palette of Autumnal tones.

**CLIFF 28-31**

**Wall mounted.**  
Cliff Hangers (towel rails) can be applied.  
Part of the Outline range, the original flat  
panel radiator design for lovers of clean lines.  
Bespoke sizes available for water models.  
Hinge & Bracket available.

**THE HOLY RAIL 32**

**Wall mounted, hydronic heating or electric.**  
The Holy Rail radiator and towel warmer is a  
room's fun, colourful friend. Choose any  
combination of two RAL colours that you love.

**SUPERMIRROR 34**

Super-high polished stainless steel giving  
a near-perfect reflection.

**BRASSY 35**

Eskimo's glamorous, highly polished brass  
radiator. Hot in all sense of the word.

## 36

**OTTINETTI VALVES**

Beautiful valves to accompany  
beautiful radiators.  
Options for both thermostatic and manual  
valves, available in a multitude of finishes.

## 37

**HIDDEN VALVES**

For lovers of clean line.  
Manual hidden valve models and  
Thermostatic Hinge & Bracket models are  
available for all central heating  
Outline radiators.

## 38

**ESKIMO'S STUNNING  
SURFACE FINISHES**

All finishes are included within your  
radiator price.

A choice of 29 RAL colours, 7 wooden  
veneers, a bamboo, 7 natural stone veneers,  
a concrete and a beautiful range of metal and  
patinated metal finishes.

## 41

**INFORMATION**

How to clean your Eskimo radiator 41  
Venting procedure 42  
Air/Gas in radiator 43  
Radiator balancing 44  
Delta T 46  
Non standard connection positions 47

**RON - CENTRAL HEATING**

In 'Copper Pipe' sublimation finish  
**(IMPORTANT: For an accurate visual of  
this copper print finish, please see your  
local Eskimo retailer for samples)**



## RON / LEGGY RON

### HYDRONIC HEATING ONLY - NOW IN OUR NEW SUBLIMATION PRINT FINISHES

Eskimo's range of elliptical aluminium column radiators, with or without legs.

Crossing the boundary between contemporary and classic. Its styling cues include 1950s aircraft technology and the traditional school house radiator.

As a result of its clever design, Ron will happily sit with most interior schemes from ultra-modern to period.

Ron is a modular aluminium high output radiator - allowing you to add as many sections as you need, from 1 to 50.

Available in a range of six standard heights. Fit long, low 200mm H versions underneath windows or shelving; or fit space saving 1.8m columns.

Wall mounted, hydronic heating with side connections for your valves.\*

Leggy Ron, floor mounted, hydronic heating, with inner leg side connections for your valves.\*

#### Metal finishes

Gold  
Matt Aluminium  
Polished

#### Colours

29 standard RAL colours available  
Or choose any RAL you like  
Or use our colour matching service  
(additional costs may apply)  
See page 36 - 38 for all standard RALs and metal finishes.

#### NEW special finishes

Copper Pipe  
Antique  
Shipyard

#### Not just printing - a decorative metal thing

We are proud to introduce another member of the talented Eskimo family. OneLBJ are a skilled specialist team who are artists in their field, based in Atherstone, Warwickshire. Their expertise are decorative finishes on to metal components. But as you can imagine, this can be done either with or without an eye for design. So Eskimo were chuffed when we finally found OneLBJ who's creativity, attention to detail, experience and design understanding ticks all the right boxes.

2017 sees the launch of three carefully selected sublimation print finishes for Eskimo's RON radiators. Shipyard, Copper Pipe and Antique. Offering RON lovers three incredibly different alternative looks to RON's original styling cues of 1950s aircraft technology.

The designers at OneLBJ and Eskimo, selected three high res images from shots of inspiration in and around a shipyard site in Bristol, Somerset.

Those images were then designed to create a surface finish for RON's curvy form.

Once the image is finalised, this then gets transferred onto a poly film. In the meantime Eskimo powder coat the RON radiator modules at our Birmingham factory, with a porous powder that's cured at a lower temperature than standard powder.

Each of the Ron sections are then wrapped in the film and heated to a high temperature - the inks on the inside of the film are transferred into the porous powder and make their way through it to the base metal.

Finally the heat cures and seals the powder so that it's no longer porous. What this means is that it is essentially a print, but not surface print - it goes right through the entire coating, meaning that if you were to scratch the RON sections you'd have to get down to base metal before you saw the scratch mark.

#### Technical

All heat outputs are calculated in accordance with BS EN442. For an explanation of Delta T ( $\Delta t$ ) and to calculate performance at different Delta Ts, please see the technical information on our website.

To convert Watts to BTU/hr, multiply the figure shown for watts by 3.412.

Test pressure: 7.5 bar.

Max. Operating Pressure: 5 bar.

Max. Operating Temperature: 95°C.

Connections: 1/2" BSP Bottom (side of radiator) opposite end tappings - use angle valves for pipes coming from either the walls or up from the floor. Valves must be ordered separately. For all installation guidelines, please see [www.eskimoheat.com.au](http://www.eskimoheat.com.au)

#### Water treatment

Unless otherwise stated these products are for use on closed heating systems only, they are not suitable for installation on secondary return hot water system. On completion of the installation the entire system MUST be thoroughly cleaned and flushed to remove debris/flux residues etc. If a chemical cleaner is used, it must be thoroughly flushed from the system. Following this, the system MUST be dosed with a corrosion inhibitor/water treatment suitable for mixed metal systems (specifically aluminium) to prevent corrosion. System design, flushing and dosing must be in accordance with BS5449:1990, BSEN12828, 2003 and BS7593:1992.

#### IMPORTANT:

Failure to observe these requirements will invalidate the warranty.

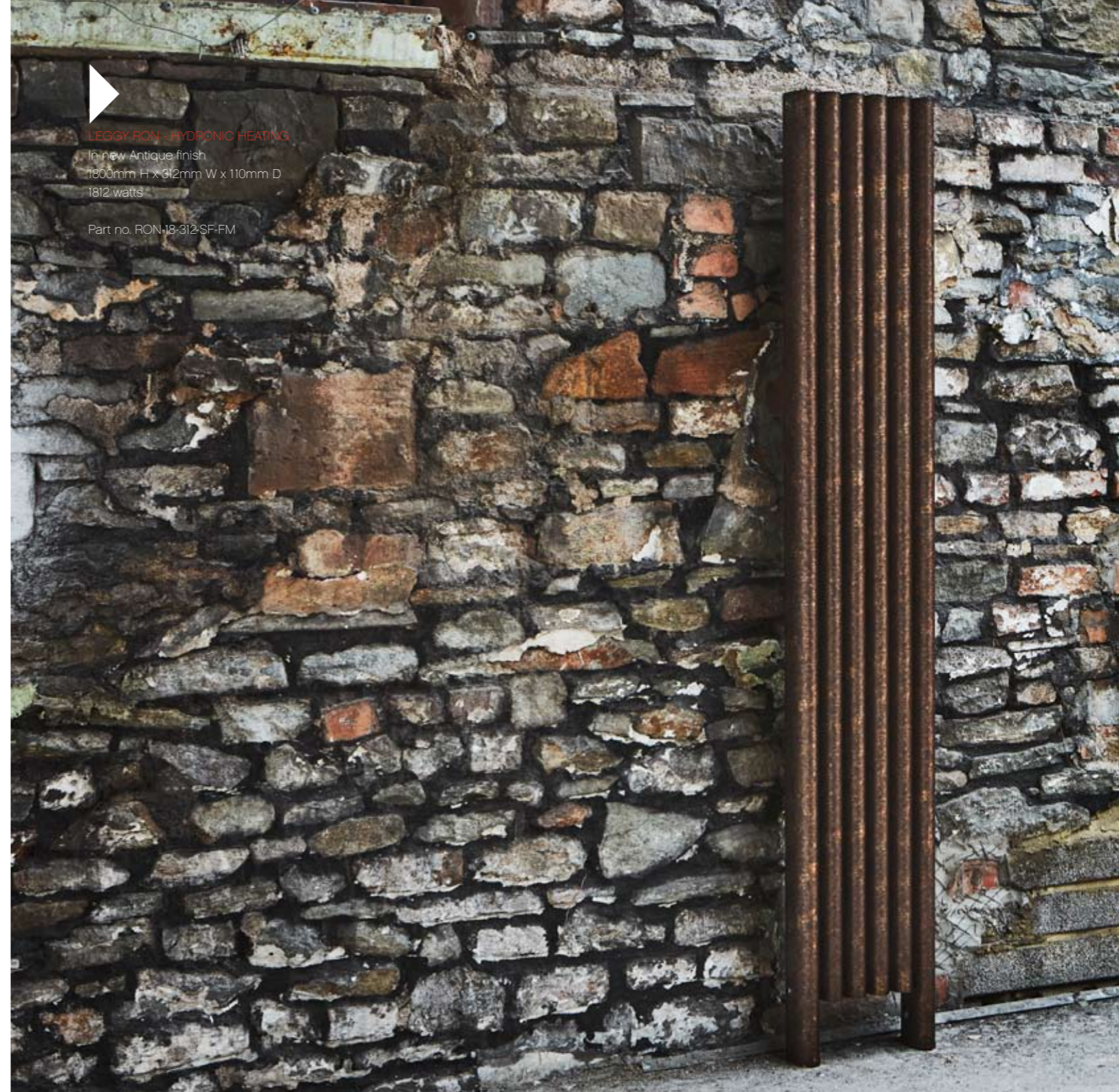

#### LEGGY RON - HYDRONIC HEATING

In new Antique finish  
1800mm H x 312mm W x 110mm D  
1812 watts

Part no. RON-18-312-SF-FM

\*Please see page 36 for information our valve sets.





LEGGY RON - HYDRONIC HEATING  
In new Copper Pipe finish  
400mm H x 832mm W x 110mm D  
1299 watts

Part no. RON-4-832-SF-FM

## SUBLIMATION PRINTS

2017 sees the launch of three carefully selected sublimation print finishes for Eskmo's RON radiators. Shipyard, Copper Pipe and Antique. Offering RON lovers three incredibly different alternative looks to RON's original styling cues of 1950s aircraft technology.

LEGGY RON - HYDRONIC HEATING  
In new 'Shipyard' finish  
600mm H x 1508mm W x 110mm D  
3341 watts

Part no. RON-6-1503-SF-FM





## TOWEL RAILS FOR RON RADIATORS

One warms your towels, the other heats your room

The matching elliptical towel rail is proportionately designed to the elliptical section of the radiator. And you can choose up to four.

The problem with most towel rails is that they only provide their full heat output so long as you don't hang towels on them. Hanging a towel on a towel rail is like putting a tea cosy on a tea pot - it keeps the heat in, resulting in a cold room. Eskimo's towel rails are different.

The Eskimo rail on the front has a separate function to the radiator at the back - one warms your towels, the other heats your room, without compromising each other.

The matching elliptical towel rail is proportionately designed to the elliptical section of the radiator, equating beautiful form.

Available in a range of three standard column heights with up to three towel rails. Towel rails can be added. Other positions are available - speak with your local retailer or go to [www.eskimoheat.com.au](http://www.eskimoheat.com.au)

**Metal finishes**  
Gold  
Matt Aluminium  
Polished

**Colours**  
29 standard RAL colours available  
Or choose any RAL you like  
Or use our colour matching service (additional costs may apply)  
See page 38-40 for all standard RALs and metal finishes.

**NEW special finishes**  
Copper Pipe  
Antique  
Shipyard

### Technical

All heat outputs are calculated in accordance with BS EN442. For an explanation of Delta T ( $\Delta t$ ) and to calculate performance at different Delta Ts, please see the technical information on our website.

To convert Watts to BTU/hr, multiply the figure shown for watts by 3.412.

Test pressure: 7.5 bar.  
Max. Operating Pressure: 5 bar.  
Max. Operating Temperature: 95°C.

Connections: 1/2" BSP Bottom (side of radiator) opposite end tappings - use angle valves for pipes coming from walls and also from the floor. Valves must be ordered separately.  
For all installation guidelines, please see [www.eskimoheat.com.au](http://www.eskimoheat.com.au)

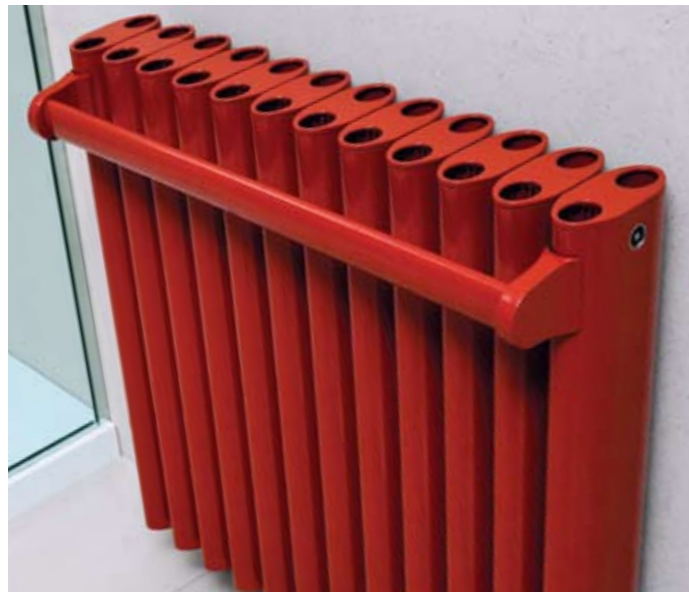



## OUTLINE - NOW IN OUR NEW CONCRETE AND MARBLE FINISHES HYDRONIC HEATING OR ELECTRIC

The original flat panel design for lovers of clean lines.  
Choose from a large selection of surface finishes.

**Our NEW real concrete veneer and NEW Marbles - three carefully selected stones. Beautifully finished and selected for contemporary living.**

Natural stone veneers applied to a fiberglass resin backing, offers an opportunity to explore the potential of natural materials that excites the designers and engineers at Eskimo.

Stone being a natural finish, it offers the most exciting variations in colour, pattern, shape/movement/formation. The great news is that your Concrete or Marble radiator is always a 'one off' unique piece. The bad news is that any natural stone product is not for the control freaks out there.

The nature of the Marble collection means that you have to get back to nature a little bit and let Eskimo help you to let go. The geological production process that made Marble so gorgeous took millennia to complete so don't expect precision in this finish. If that is what you need then Marble is not for you. Outline is a modular aluminium, high output radiator 'engine' with various stunning options of front fascia. Available in two standard depths and 25 standard sizes. Bespoke sizes are also readily available - we make Outline to the nearest mm to fit odd spaces and match existing pipe centres, reducing your installation costs. You can specify Hinge & Bracket too, so that, for example with Supermirror, the mirror panel appears to "float" just off of the wall with the radiator function disguised yet still accessible so

that you have full thermostatic control on a water model. See pg 37 for further info.

You can also opt for fitted towel rails to create a high performance radiator and towel warmer combined.

**Hydronic heating or electric models are available in this Outline radiator range.**

### **Metal finishes**

Supermirror  
Brassy  
Brushed  
Gong  
Rusty

### **Colours**

29 standard RAL colours  
Or choose any RAL you like (additional cost)  
Or use our colour matching service (additional cost)  
See page 38-40 for all standard RALs and metal finishes.

### **Veneers**

Woody - Oak, Fumed Oak, Walnut, Pippy Oak, Tropical Olive, Rosewood and Zebrano. Bamboo.  
Cliff - Earthy Pit, Schistian Slater, Flint Eastwood and Barren Stone.  
Concrete.  
Marbles - Bianco Carrara, Crema Marfil, Walnut Travertine.

Hinge & Bracket, access to controls, is available.

Hidden manual valves, no access, also available.

**Towel hanging rails, in the same finish, for some Outline radiators. (5mm x 40mm strips) can be added.**

**Cliff Hangers and special finishes towel hanging rails:** Alternative towel hanging rails in chrome can be added. In single or double styles.



### **OUTLINE - HYDRONIC HEATING**

In Concrete finish  
Lie Down Outline radiator  
600mm H x 2200mm W x 61mm D  
With Hinge & Bracket hidden valves  
2106 watts / 7189 Btu/Hr

Part no. 22060S-CON-HB





#### Technical

All heat outputs are calculated in accordance with BS EN442. For an explanation of Delta T ( $\Delta t$ ) and to calculate performance at different Delta Ts, please see the technical information on our website. To convert Watts to BTU/hr, multiply the figure shown for watts by 3.412.

Test pressure: 7.5 bar.  
Max. Operating Pressure: 5 bar.  
Max. Operating Temperature: 95°C.  
Connections: 1/2" BSP Bottom (underside of radiator) opposite end tapings - use angle valves for pipes coming from walls and straight valves for pipes coming up from the floor. Valves must be ordered separately. For all installation guidelines, please see [www.eskimoheat.com.au](http://www.eskimoheat.com.au)

#### Water treatment

Unless otherwise stated these products are for use on closed heating systems only, they are not suitable for installation on secondary return hot water system. On completion of the installation the entire system MUST be thoroughly cleaned and flushed to remove debris. If a chemical cleaner is used, it must be thoroughly flushed from the system. Following this, the system MUST be dosed with a corrosion inhibitor/ water treatment suitable for mixed metal systems (specifically aluminium) to prevent corrosion. System design, flushing and dosing must be in accordance with BS5449:1990, BSEN12828, 2003 and BS7593:1992.

#### IMPORTANT:

Failure to observe these requirements will invalidate the warranty.

#### OUTLINE - HYDRONIC HEATING

Get Up Outline radiator in Crema Marfil real marble finish 1824mm H x 454mm W x 61mm D With Hinge & Bracket hidden valves 1571 watts / 5362 Btu/Hr

Part no. 4541824S-M-HB

#### OUTLINE - ELECTRIC

Get Up Outline radiator in Bianca Carrara real marble finish 1924mm H x 484mm W x 61mm D 1740 watts / 5938 Btu/Hr

Part no. DE1924484S-M

#### OUTLINE - HYDRONIC HEATING

Get Up Outline radiator in Walnut Travertine real marble finish 454mm H x 2024mm W x 61mm D 979 watts / 3341 Btu/Hr

Part no. 2024454S-M-HB

## OUTLINE RADIATORS - ELECTRIC:

The original flat panel design for lovers of clean lines.

Choose from a large selection of surface finishes. You can choose The Holy Rail towel radiator in electric too.

Eskimo spent over 2 years in research and development of their latest Outline “dry electric” modular heating element.

Coupling a high efficiency, natural convection aluminium heat exchanger to a powerful electric resistance heating element, the design has been honed to provide the maximum heat output within the space envelope available without resorting to noisy and impossible to clean fans or the very high surface temperatures associated with radiant heating panels.

### What this means to our clients

Eskimo’s electric range delivers huge heat outputs from radiators that are in most cases smaller than their central heating cousins.

There is no visible electric control gear – all you see is the geometric shape of the radiator with a power cable exiting from the underside.

They are lightweight with a low thermal mass. This makes them quick to heat up and cool down making them highly controllable, saving electricity costs over the life of the product compared to underfloor heating or storage heaters.

Coupled with a programmable thermostatic system we calculate that you can save between 12 & 18% of your energy costs compared to the alternatives.

Unlike most products on the market they are not cannibalised versions of central heating radiators with a heating element added on. They are not fluid filled making them, more reliable (there is no fluid to cause leaks) more controllable and with an even distribution of heat across the surface of the radiator.

They provide a good split between radiant heat (the heat you feel from a fire or the sun) and convected heat (raising the temperature by moving warm air around the room). This makes the room a much more comfortable and pleasant environment.

They are incredibly easy to install and can be controlled by either our own wireless programmable room thermostats (see page 15) or via any other thermostatic control system.

In RAL9016 Traffic White they are a very cost effective alternative for commercial and hotel interiors.

### Outline radiator range. Metal finishes

Supermirror  
Brassy  
Brushed  
Gong  
Rusty

### Colours

29 standard RAL colours  
Or choose any RAL you like (additional cost)  
Or use our colour matching service (additional cost)  
See page 38 - 40 for all standard RALs and metal finishes.

### Veneers

Woody - Oak, Fumed Oak, Walnut, Pippy Oak, Zebrano, Tropical Olive and Rosewood. Bamboo.  
Cliff - Earthy Pit, Schistian Slater, Flint Eastwood and Barren Stone.  
Concrete.  
Marbles - Bianco Carrara, Crema Marfil, Walnut Travertine.

For all installation guidelines, please see [www.eskimoheat.com.au](http://www.eskimoheat.com.au)

Towel hanging rails, in the same finish, for some Outline radiators. (5mm x 40mm strips) can be added.

Cliff Hangers and special finishes towel hanging rails: Alternative towel hanging rails in chrome can be added. Single or double styles.

TYDOM is a new generation of Home Automation solution that enables you to control a house, a second home or an office, locally or remotely, from a Smartphone or tablet.

Simplicity for each member of the family. TYDOM makes life easier, more comfortable and secure. You can even make energy savings too.

Without subscription, each TYDOM solution includes a gateway and an application to control the connected devices. The application can be personalised with a library of icons or with actual photos of the room.

## ELECTRIC CONTROLS - NEW TYDOM HOME AUTOMATION SOLUTION

Accompanying controls for all electric radiators.



Receiver  
Part No. 7729997

TYBOX 5101 wireless room thermostat-  
Part no. 6300045

TYDOM 1.0 Internet gateway  
(All programming done via TYDOM 1.0)  
Part no. 6700107





OUTLINE - ELECTRIC



OUTLINE - ELECTRIC  
Lie Down ELECTRIC Outline radiator  
in finish RAL 9016 Traffic White  
290mm H x 1600mm W x 95mm D  
868 watts / 2961 Btu/Hr

Part no. DE29160D-C9016



## OUTLINE WOODY - WOOD VENEERS - NOW IN OUR NEW ENVIRONMENTALLY FRIENDLY BAMBOO FINISH

Combining the unique aesthetic properties of wood or bamboo, with the thermal performance of aluminium.

Outline is a modular aluminium, high output radiator 'engine' with various stunning options of front fascia. Which include beautiful wood veneers produced by one of the UK's most skilled furniture makers and veneer contemporaries. And the new Bamboo produced by a leading environmentally friendly supplier.

Available in two standard depths, shallow and deep, 61mm and 106mm respectively – with the deep version giving double the heat output. And 25 standard radiator sizes.

Bespoke sizes are also readily available - we make Outline to the nearest mm to fit odd spaces and match existing pipe centres, reducing your installation costs.

You can specify Hinge & Bracket so that, the stunning, warm wood appears to "float" just off of the wall with the radiator function disguised yet still accessible so that you have full thermostatic control. For hidden heating it's better than underfloor too because it has proper temperature control. See pg 37 for further information.

Hydronic heating or electric models are available.

NOW introducing a further four new wood finishes, Eskimo offer you seven real wood radiators and one very enviro. friendly bamboo. You can also opt to add towel rails in the same finish.

One of reasons for using wood or bamboo\* is that you get a very nice and even gentle spread of temperature with no hot spots, even when the radiator 'engine' itself is delivering high heat output.

### Woody's finishes

Oak  
Walnut  
Fumed Oak  
Bamboo  
Tropical Olive  
Rosewood  
Zebrano  
Pippy Oak

**Towel hanging rails, in the same finish, for some Outline radiators.** (5mm x 40mm strips) can be added.

**Cliff Hangers and special finishes towel hanging rails:** Alternative towel hanging rails in chrome can be added. Single or double styles.

**\*As you'd expect from Eskimo, we only use timber from well managed forests, using sustainable, FSC certified sources. And once again our suppliers are British.**

### Bamboo – more than a wood alternative

Bamboo replenishes itself quickly. It is a grass with wood-like characteristics, growing up to 1 metre per day in tropical regions, making it the fastest growing plant on earth.

### Environmentally friendly

Every year the parent bamboo plant develops new stems. These new stems can be harvested after 5 years in a mature plantation without decreasing the size of the forest. Regular harvesting actually improves the growth of the bamboo.

The supplier that we work with opts for an environmentally friendly approach in the processing of bamboo strips for our radiator veneers. If required, 100% formaldehyde free glue is used and meet the requirements set out in the European standard E1 norm.

Over the years, FSC has become an important international standard. Bamboo is not a wood, it is a grass. And to produce bamboo products no deforestation is necessary or even possible: only the 5-6 years old plants are harvested. However, a lot of building contracts required FSC only materials. So in 2004 FSC has allowed bamboo into their system.

### No threat to Pandas

Pandas live in the mountain ranges of central China and forage where the shorter species of bamboo are more accessible. The taller bamboo species has no leaf growth on the first metre of the stem, and is therefore not a food source for the panda.

### Technical

Tests on Eskimo's thermal cycling rig included cooling down to ambient temperature and heating up to 80 degrees Celsius whilst being automatically sprayed at 5 minute intervals with water. It remained completely unaffected by high temperature fluctuations and damp and humid environments. There was no damage to the surface finish found - the Woody remained as beautiful as before its test.

In short Woody is the perfect bathroom radiator as well as other areas of your home.

### Water treatment

Unless otherwise stated these products are for use on closed heating systems only, they are not suitable for installation on secondary return hot water system. On completion of the installation the entire system MUST be thoroughly cleaned and flushed to remove debris/flux residues etc. If a chemical cleaner is used, it must be thoroughly flushed from the system. Following this, the system MUST be dosed with a corrosion inhibitor/water treatment suitable for mixed metal systems (specifically aluminium) to prevent corrosion. System design, flushing and dosing must be in accordance with BS5449: 1990, BSEN12828, 2003 and BS7593:1992.

### IMPORTANT:

Failure to observe these requirements will invalidate the warranty.







**WOODY - HYDRONIC HEATING**  
In Walnut finish  
Standard bottom end connections  
Get Up Outline radiator  
1524mm H x 454mm W x 106mm D  
2222 watts / 7583 Btu/Hr

Part no. 45.4152.4D-W

Valves, Thermostatic Series B angled in white



**WOODY - HYDRONIC HEATING**  
In Oak finish  
With Hinge & Bracket  
Get Up Outline radiator  
1824mm H x 454mm W x 61mm D  
1571 watts / 5362 Btu/Hr

Part no. 45.4182.4S-WHB



**BAMBOO - ELECTRIC**  
Get Up Outline radiator  
1924mm H x 484mm W x 61mm D  
1740 watts / 5938 Btu/Hr

Part no. DE192.448.4S-BAM





## OUTLINE GONG - PATINATED METALS; BRASS, COPPER AND STEEL

Beautifully patinated brass, copper and steel finishes applied to Eskimo's super-powerful radiators.

The Outline radiator range is a modular aluminium, high output radiator 'engine', encased within various stunning options of front fascia panel.

Huge attention has gone into ensuring that the lines of the product are clean and uncluttered, allowing the stunning opulence of Gong's hand patinated brass and copper finishes to speak for themselves.

The patinas of Gong are applied by hand by highly skilled metalworkers, Capisco, in London's East End. Using a variety of hot working techniques and colour compounds depending on the finish.

Due to the hand finished nature of the patinas, every Gong is different in tone and pattern each time.

The great news is that your Gong radiator is always a 'one off' unique piece.

The bad news is that Gong is not for the control freaks out there.

Hand patination technique means that your Gong will not be exactly the same as the pictures that you see here or the samples that you may see at your local Eskimo retailer. As with all of our hand patinated finishes within the Outline radiator range, we

cannot orchestrate the surface area of either pattern or colour palette beyond the parameters that we have set for each patina technique to achieve a certain range of colour and pattern for each finish that we've selected.

We can show you examples of what you COULD receive but the pattern will vary slightly. The colour palette that we've carefully chosen WILL be present, but in what percentage is for us to wait and see.

That's the exciting thing about patinated coppers and brass. You cannot control the finish completely and nor should you want to. Think of it as a piece of abstract contemporary art and see the beauty in its random creativity.

The allure of these radiators is that they are unique. No one radiator is the same. Our hand patinated finishes are signed off in accordance with defined production processes. Therefore, if you are not happy with the finish we'll always listen and try to help, but controlling the production process is what we do. What we can't do is control the precise nature of the results so this needs to be factored into your decision at the specification stage rather than when the product arrives on site, by which point it is too late for us to make any alterations.

### Gong's finishes:

Brassy Knoll  
Patinated brass – granite grey base with sea green highlights.

Mighty Magmas  
Patinated copper – an earthy pallet of burnt orange and rose tones.

Midnight Caller  
Patinated brass – aggregate greys washed with a night sky blue.

Dusky Moodstress  
Patinated brass – dark chocolate brown with warm golden hints.

Available in two standard depths and 25 standard sizes. Bespoke sizes are also readily available - we make Outline radiators to the nearest mm to fit odd spaces and match existing pipe centres, reducing your installation costs.

You can specify Hinge & Bracket so that the monolithic piece of art appears to "float" just off of the wall with the radiator function disguised yet still accessible so that you have full thermostatic control. See pg 37 .

Hinge & Bracket, access to controls, is available.

Hidden manual valves, no access, also available.

Hydronic heating or electric models are available in this Outline radiator range.

Towel hanging rails (5mm x 40mm strips) can be added.

Cliff Hangers:  
Alternative towel hanging rails in chrome can be added. Single or double styles.

### Technical

All heat outputs are calculated in accordance with BS EN442. For an explanation of Delta T ( $\Delta t$ ) and to calculate performance at different Delta Ts, please see the technical information on our website. To convert Watts to BTU/hr, multiply the figure shown for watts by 3.412. Test pressure: 7.5 bar. Max. Operating Pressure: 5 bar. Max. Operating Temperature: 95°C. Connections: 1/2" BSP Bottom (underside of radiator) opposite end tappings - use angle valves for pipes coming from walls and straight valves for pipes coming up from the floor. Valves must be ordered separately. For all installation guidelines, please see [www.eskimoheat.com.au](http://www.eskimoheat.com.au)

### Water treatment

Unless otherwise stated these products are for use on closed heating systems only, they are not suitable for installation on secondary return hot water system. On completion of the installation the entire system MUST be thoroughly cleaned and flushed to remove debris/flux residues etc. If a chemical cleaner is used, it must be thoroughly flushed from the system. Following this, the system MUST be dosed with a corrosion inhibitor/water treatment suitable for mixed metal systems (specifically aluminium) to prevent corrosion. System design, flushing and dosing must be in accordance with BS5449: 1990, BSEN12828, 2003 and BS7593:1992.

### IMPORTANT:

Failure to observe these requirements will invalidate the warranty.



GONG

Close up of 'Dusky Moodstress' finish





**GONG - HYDRONIC HEATING**  
**(IMPORTANT: For an accurate visual of this hand patinated finish, please see your local Eskimo retailer for samples)**

Get Up Outline radiator  
In Brassy Knoll finish  
With Hinge & Bracket hidden valves  
2000mm H x 430mm W x 50mm D  
1771 watts / 6045 Btu/Hr

Part no. 43200S-G-HB

Set of Chrome TRV thermostatic valves and flexible hoses are included.



**GONG - ELECTRIC**  
**(IMPORTANT: For an accurate visual of this hand patinated finish, please see your local Eskimo retailer for samples)**

Lie Down Outline radiator  
In Dusky Moodstress finish  
650mm H x 1100mm W x 95mm D  
1735 watts / 5922 Btu/Hr

Part no. DE65110D-G



## RUSTY

The edgier, more industrial cousin from the Midlands, Rusty is a very popular member of the Outline radiator family.

Hand patinated steel, sealed with a hardwax oil to lock in its beauty.

The Outline radiator range is a modular aluminium, high output radiator 'engine', encased within various stunning options of front fascia.

### Hydronic heating or electric models are available.

Unlike the patinated copper or brass of Gong. Rusty is a steel finish that has also been hand-patinated using a unique ageing technique developed exclusively by Eskimo to create a stunning palette of Autumnal tones.

This technique produces a depth or richness loved by our Eskimo customers. The most exciting undulations can often occur, a meander of deep chocolates, occasionally black, maybe rare pinches of deep burgandy through a 'sea' of a warm Autumnal colour palette.

The great news is that your Rusty radiator is always a 'one off' unique piece.

The bad news is that Rusty is not for the control freaks out there. Hand patination technique means that you have to be willing to expect the unexpected.

Your Rusty may present itself dramatically with larger pattern formations and depth of colour. OR it may take a more subtle form with a uniformed patina

and less depth in colour palette. Rusty is always warm in colour but can range from the deep dark chocolates through to the light, bright oranges.

You cannot control Rusty's finish and nor should you want to. Think of it as a piece of abstract contemporary art and see the beauty in its random creativity.

As with all of our hand patinated finishes within the Outline radiator range, we cannot orchestrate the surface area of either pattern or colour palette beyond the parameters that we have set for each patina technique to achieve a certain range of colour and pattern for each finish that we've selected. The beauty of these products is that they are unique. No one radiator is the same. Our hand patinated finishes are signed off in accordance with defined production processes. Therefore, if you are not happy with the finish we'll always listen and try to help, but controlling the production process is what we do. What we can't do is control the precise nature of the results so this needs to be factored into your decision at the specification stage rather than when the product arrives on site, by which point it is too late for us to make any alterations.

Available in two standard depths and 25 standard sizes. Bespoke sizes are also readily available - we make Outline radiators to the nearest mm to fit odd spaces and match existing pipe centres, reducing your installation costs.

You can specify Hinge & Bracket so that the monolithic rusty panel appears to "float" just off of the wall with the radiator function disguised yet still accessible so that you have full thermostatic control. See pg 37.

Hinge & Bracket, access to controls, is available.

**Towel hanging rails** (5mm x 40mm strips) can be added.

**Cliff Hangers:** Alternative towel hanging rails in chrome can be added. Single or double styles.

### Technical

All heat outputs are calculated in accordance with BS EN442.

For an explanation of Delta T ( $\Delta t$ ) and to calculate performance at different Delta Ts, please see the technical information on our website. To convert Watts to BTU/hr, multiply the figure shown for watts by 3.412. Test pressure: 7.5 bar.

Max. Operating Pressure: 5 bar.

Max. Operating Temperature: 95°C.

Connections: 1/2" BSP Bottom (underside of radiator) opposite end tappings - use angle valves for pipes coming from walls and straight valves for pipes coming up from the floor. Valves must be ordered separately.

For all installation guidelines, please see [www.eskimoheat.com.au](http://www.eskimoheat.com.au)

### Water treatment

Unless otherwise stated these products are for use on closed heating systems only, they are not suitable for installation on secondary return hot water system. On completion of the installation the entire system MUST be thoroughly cleaned and flushed to remove debris/flux residues etc. If a chemical cleaner is used, it must be thoroughly flushed from the system. Following this, the system MUST be dosed with a corrosion inhibitor/water treatment suitable for mixed metal systems (specifically aluminium) to prevent corrosion. System design, flushing and dosing must be in accordance with BS5449: 1990, BSEN12828, 2003 and BS7593:1992.

### IMPORTANT:

Failure to observe these requirements will invalidate the warranty.

## RUSTY

Rusty is one of the lucky models who gets the option of having the Hinge & Bracket design. Pipes and thermostatic controls are all hidden away, yet completely accessible when the radiator is "opened". Oh it's good to be clean lined, beautiful and in control isn't it?

Please note :

All Hinge & Bracket models require 430mm minimum in length and depth. Anything smaller will require either hidden manual valves or standard bottom end connections.

**RUSTY - HYDRONIC HEATING**  
**(IMPORTANT: For an accurate visual of this hand patinated finish, please see your local Eskimo retailer for samples)**

With Hinge & Bracket hidden valves  
2000 H x 430mm W x 50mm D  
1771 watts / 6045 Btu/Hr

Part no. 43200S-R-HB

Set of Chrome TRV thermostatic valves and flexible hoses are included.



## CLIFF

Exquisite stone veneer collection.

Part of Eskimo's Outline radiator range, the original flat panel design for lovers of clean lines.

The Outline radiator range is a modular aluminium, high output radiator 'engine', encased within various stunning options of front fascia.

Stone being a natural finish, it offers the most exciting variations in colour, pattern, shape/movement/formation.

The great news is that your Cliff radiator is always a 'one off' unique piece.

The bad news is that Cliff is not for the control freaks out there.

The nature of this collection means that you have to get back to nature a little bit and let Eskimo help you to let go. Cliff is as natural as it's namesake (of the vertical rock wall variety rather than the Richards version). The geological production process that made Cliff so gorgeous took millennia to complete so don't expect precision in this finish. If that is what you need then Cliff is not for you.

Cliff hangers make for great drama, they also make for great towel rails to create a high performance radiator and towel warmer combined.

### Cliff Hangers:

Towel hanging rails in chrome can be added. Single and double styles.

Available in two standard depths and 25 standard sizes. Bespoke sizes are also readily available - we make Outline radiators to the nearest millimetre to fit odd spaces and match existing pipe centres, reducing your installation costs.

You can specify Hinge & Bracket so that the monolithic stone panel appears to "float" just off of the wall with the radiator function disguised yet still accessible so that you have full thermostatic control. See pg 37.

**Hydronic heating or electric models are available in this Outline radiator range.**

The Cliff finish is a natural stone veneer with a high degree of surface texture. As such there is a greater potential for dimensional variation. Please allow for a dimensional tolerance of +/- 6mm in the size of the radiator.

### Cliff's finishes

**Earthy Pit**  
A soil/earthy colour palette with hints of dark chocolate brown, anthracite greys and moss green hues.

**Schistian Slater**  
Cool greys with a sparkling surface finish.

**Flint Eastwood**  
Very dark mat slate grey to almost black.

**Barren Stone**  
A lighter 'Desert' stone colour spectrum, mainly warm with hints of sandstone and rock formation greys and browns. Our Cliff finish with the widest potential variation and colour palette; not for the faint hearted. Whatever you end up with will be glorious but don't go for Baron Stone unless you love a bit of drama.

Hinge & Bracket, access to controls, is available. Hidden manual valves, no access, also available.

### Technical

All heat outputs are calculated in accordance with BS EN442. For an explanation of Delta T ( $\Delta t$ ) and to calculate performance at different Delta Ts, please see the technical information on our website. To convert Watts to BTU/hr, multiply the figure shown for watts by 3.412. Test pressure: 7.5 bar. Max. Operating Pressure: 5 bar. Max. Operating Temperature: 95°C. Connections: 1/2" BSP Bottom (underside of radiator) opposite end tapings - use angle valves for pipes coming from walls and straight valves for pipes coming up from the floor. Valves must be ordered separately. For all installation guidelines, please see [www.eskimoheat.com.au](http://www.eskimoheat.com.au)

### Water treatment

Unless otherwise stated these products are for use on closed heating systems only, they are not suitable for installation on secondary return hot water system. On completion of the installation the entire system MUST be thoroughly cleaned and flushed to remove debris/flux residues etc. If a chemical cleaner is used, it must be thoroughly flushed from the system. Following this, the system MUST be dosed with a corrosion inhibitor/water treatment suitable for mixed metal systems (specifically aluminium) to prevent corrosion. System design, flushing and dosing must be in accordance with BS5449: 1990, BSEN12828, 2003 and BS7593:1992.

### IMPORTANT:

Failure to observe these requirements will invalidate the warranty.



### CLIFF - HYDRONIC HEATING

In Barren Stone finish  
**(IMPORTANT: For an accurate visual of this stone veneer finish, please see your local Eskimo retailer for samples)**

Lie Down Outline radiator  
624mm H x 824mm W x 61mm D  
With Hinge & Bracket hidden valves  
641 watts / 2188 Btu/Hr

Part no. 624824S-CL-HB





**CLIFF - CENTRAL HEATING**

In Earthy Pit finish

**(IMPORTANT: For an accurate visual of this stone veneer finish, please see your local Eskimo retailer for samples)**

Get Up Outline radiator

1824mm H x 454mm W x 106mm D

With Hinge & Bracket hidden valves

Lead time 6 weeks

2749 watts / 9382 Btu/Hr

Part no. 4541824D-CL-HB



**CLIFF - ELECTRIC**

In Schistian Slater stone finish

**(IMPORTANT: For an accurate visual of this stone veneer finish, please see your local Eskimo retailer for samples)**

Lie Down Outline radiator

314mm H x 2124mm W x 61mm D

789 watts / 2693 Btu/Hr

Part no. DE3142124S-CL



## OUTLINE - TWO COLOUR TOWEL WARMER - THE HOLY RAIL HYDRONIC HEATING OR ELECTRIC

A splash of colour, a lot of heat and toasty towels

The Outline radiator range is a modular aluminium, high output radiator 'engine', encased within various stunning options of front fascia.

The Holy Rail radiator and towel warmer is a room's fun, colourful friend. You can choose any two colours that blend beautifully within your interior design or any two colours that just take your fancy.

Fun, colourful friends can also be surprisingly practical if you look beneath the surface and this one pumps out a high heat output via it's hidden modular aluminium radiator 'engine'. A powder coated steel front fascia panel and towel slot shell makes this an inspired dual purpose design, both heating your room and warming your towels.

We've considered your luxury chunky bath towels, we've thought about a family's haste and we've added to our mission statement of ridding the world of ugly radiators - another priority. The end of wet towels being left on floors, beds, chairs and banisters. Imagine this world. Our new design allows the stuffing of towels into a slot on the way out.

Could it be true? The ever frustrated 'towel picker-upper' may finally have found it. The Holy Rail.

Available in six standard sizes and a choice of 29 standard colours that are included within the price. Alternatively you can

have any colours you choose for a small additional cost. We are even happy to create special one-off combinations perhaps including our metal finishes such as Supermirror.

Wall mounted, hydronic heating with bottom end connections for your valves.

Available in hydronic heating or electric models.

### Colours

29 standard RAL colours available.

Or choose any RAL you like (additional cost).  
Or use our colour matching service (additional cost).

### Metal finishes

On special request.

See page 38 for all metal finishes and standard RALs.

### Technical

All heat outputs are calculated in accordance with BS EN442. For an explanation of Delta T ( $\Delta t$ ) and to calculate performance at different Delta Ts, please see the technical information on our website.

To convert Watts to BTU/hr, multiply the figure shown for watts by 3.412.

Test pressure: 7.5 bar.

Max. Operating Pressure: 5 bar.

Max. Operating Temperature: 95°C.

Connections: 1/2" BSP Bottom (side of radiator) opposite end tappings - use angle valves for pipes coming from either the walls or up from the floor. Valves must be ordered separately. For all installation guidelines, please see [www.eskimoheat.com.au](http://www.eskimoheat.com.au)

### Water treatment

Unless otherwise stated these products are for use on closed heating systems only, they are not suitable for installation on secondary return hot water system. On completion of the installation the entire system MUST be thoroughly cleaned and flushed to remove debris/flux residues etc. If a chemical cleaner is used, it must be thoroughly flushed from the system. Following this, the system MUST be dosed with a corrosion inhibitor/water treatment suitable for mixed metal systems (specifically aluminium) to prevent corrosion. System design, flushing and dosing must be in accordance with BS5449: 1990, BSEN12828, 2003 and BS7593:1992.

### IMPORTANT:

Failure to observe these requirements will invalidate the warranty.



### THE HOLY RAIL - ELECTRIC

In RAL 9016 Traffic White & Supermirror

Get Up ELECTRIC

1200mm H x 650mm W x 110mm D

870 watts / 2969 Btu/Hr

Part no. DEHR65120-C9016/SM





**SUPERMIRROR - HYDRONIC HEATING**  
Get Up Outline radiator  
1800mm H x 430mm W x 50mm D  
With Hinge & Bracket hidden valves  
1571 watts / 5362 Btu/Hr  
  
Part no. 43180S-SM-HB



**BRASSY - HYDRONIC HEATING**  
Get Up Outline radiator  
1800mm H x 430mm W x 95mm D  
2959 watts / 10099 Btu/Hr  
  
Part no. 43180D-BR  
  
Set of TRV Thermostatic valves in Gold  
Part no. TRV-OD-A-G

**(IMPORTANT: Brass will tarnish over time. Remember Great Grandma polishing her brass? It's very theraputic. Well if you like Brassy highly polished, book yourself in for a good old buff from time to time. Otherwise love the natural evolution of this beautiful metal).**



## OTTINETTI VALVES

The perfect accompaniment. The perfect partnership  
After scouring the planet for the perfect valves to match Eskimo's aesthetic and quality standards, Ottinetti shone out as the best valves available anywhere.

Ottinetti provide options for both thermostatic and manual valves, available in a multitude of finishes. Valves that don't let their radiators down in visual appeal or performance.

Phil Ward, Managing Director of Eskimo states: "If you're going to have an Eskimo, you want to be sure that the valves that are fitted with it will match the quality of the radiator itself – Eskimo's partnership with Ottinetti will ensure that."

We needed to be certain that we chose a partner whose values mirrored our own. Ottinetti is a family run business where the owners take huge pride in their product and understand the importance of attention to design and finish details."

Thermostatic and manual sets.

### Metal finishes

Brushed nickel  
Chrome  
Gold  
Matt  
Antique copper

### Colours

White  
Black

### Configuration

Angled  
Straight  
Corner left  
Corner right



**MATT**  
Manual valve set, Series C, angled, in matt.  
Complete valve sets only, supplied.  
Part no. MV-OC-A-M



**BRUSHED NICKEL**  
Manual valve set, Series C, angled, in brushed nickel.  
Complete valve sets only, supplied.  
Part no. MV-OC-A-B



**CHROME**  
Thermostatic TRV Series B head in polished chrome.  
Complete valve sets only, supplied.  
Part no. TRV-OB-A-P (for an angled set).

We really love the Series B TRV head option for all finishes, but it really is a matter of personal taste. So we offer Series A, Series C and Series D sets too.

Some examples are given here.



**ANTIQUÉ COPPER**  
Thermostatic valve set, TRV Series D, corner left hand flow, in antique copper.  
Complete valve sets only, supplied.  
Part no. TRV-OD-CL-CU.



**WHITE**  
Options available.



**GOLD**  
Thermostatic TRV head, Series D, in Gold  
Part of a complete set, options available.  
Part no. TRV-OD-A-G (for an angled set).

## HIDDEN VALVES AND HINGE & BRACKET - FOR LOVERS OF A CLEAN LINE

Valves are an important part of a heating system - they allow the radiator to be controlled and maintained, but at least with Eskimo's hidden valve systems, they can become your dirty little secret if you want.

Valves are an important part of a heating system, allowing the radiator to be controlled and maintained, but at least with our hidden valve systems, they can be your dirty little secret.

Even though, in Ottinetti, we have selected the world's most beautiful valves to partner our radiators they can be a distraction from our clean lines. We've resolved this with our hidden manual valve solution and our Hinge & Bracket option on Outline radiators.

Our Hidden Manual Valves are a simple modification, employing flexible hoses incorporating simple quarter turn ball valves (operated by a screwdriver) that allow the radiator to be connected to the pipework prior to being hung. The radiator is then set up by the plumber to check the operation before being hung on the wall on the brackets provided. The flexible hoses are then coiled up and hidden behind the extended front panel.

This a relatively low cost solution suitable for bathrooms and other areas where thermostatic control of the radiator may not always be required, or where a room thermostat is installed to turn the radiator on and off.

Please note that turning the radiator off for maintenance will necessitate taking the radiator off it's brackets and turning the valves off - the valves cannot be turned off without first unhooking the radiator.

Our Hinge & Bracket design goes one step further. It has all the benefits of our hidden manual valve system but with full thermostatic controls that are completely accessible when the radiator is "opened". And it couldn't be simpler...

Hinge and Bracket Outline radiators are hinged at the top and are opened by pushing the bottom of the radiator inwards slightly to release a latch.

The radiator then pivots forward on the top hinges with the use of two gas struts that take the weight of the radiator and keep it open while you adjust the valves to your desired temperature. Then pushed back into position until the latch engages.

Radiator dimensions must be at least 430mm wide/high to incorporate the included set of chrome thermostatic valves and hinge system.



Open



Closed



# ESKIMO FINISHES

## OUTLINE STANDARDS



BRUSHED

## OUTLINE REFLECTIVES

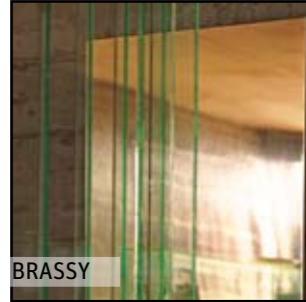

BRASSY



SUPERMIRROR

## OUTLINE TWO COLOURS TOWEL WARMER, THE HOLY RAIL



ANY TWO RAL COLOURS

## OUTLINE - PATINATED METALS; BRASS, COPPER AND STEEL

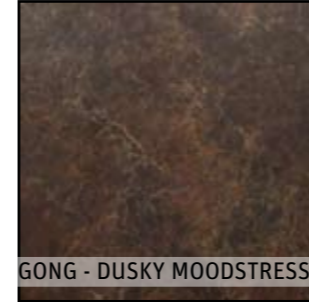

GONG - DUSKY MOODSTRESS



GONG - BRASSY KNOLL



GONG - MIDNIGHT CALLER

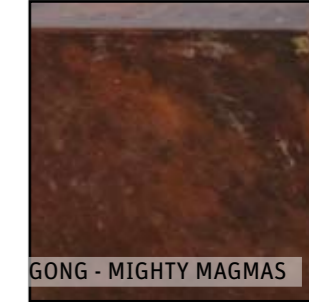

GONG - MIGHTY MAGMAS

## OUTLINE STONE VENEERS



CLIFF - FLINT EASTWOOD



CLIFF - EARTHY PIT



CLIFF - BARREN STONE



CLIFF - SCHISTIAN SLATER



RUSTY

## OUTLINE MARBLES



CREMA MARFIL



WALNUT TRAVERTINE



BIANCA CARRARA

## OUTLINE WOOD VENEERS



WOODY - OAK

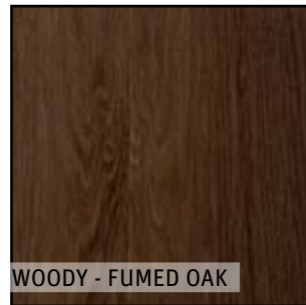

WOODY - FUMED OAK



WOODY - WALNUT

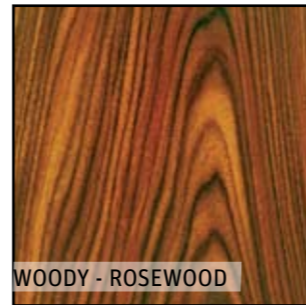

WOODY - ROSEWOOD

## OUTLINE CONCRETE



CONCRETE

## RON - METAL FINISHES



GOLD



POLISHED ALUMINIUM



MATT ALUMINIUM

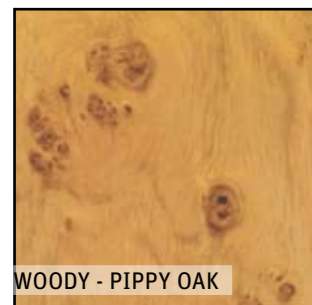

WOODY - PIPPY OAK

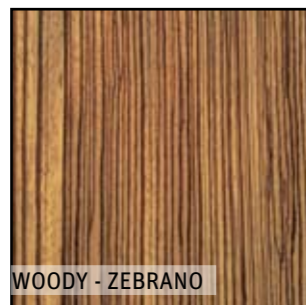

WOODY - ZEBRANO



WOODY - TROPICAL OLIVE

## OUTLINE SUSTAINABLE

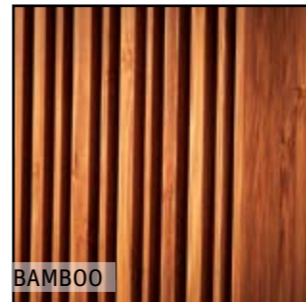

BAMBOO

## RON - SPECIAL FINISHES - SUBLIMATION PRINTING



COPPER PIPE



SHIPYARD



ANTIQUÉ



# ESKIMO'S STANDARD RAL

## IVORY AND CREAM

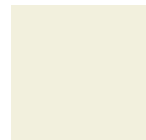

RAL 9001 CREAM



RAL 1015 LIGHT IVORY

## BLUES



RAL 5013 COBALT BLUE



RAL 5024 PASTEL BLUE

## METALLICS

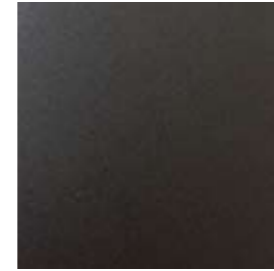

COMPOST

## WHITES & BLACKS



RAL 9002 GREY WHITE

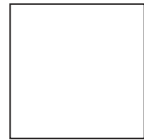

RAL 9003 SIGNAL WHITE



RAL 9005 JET BLACK

## GREEN



RAL 7002 OLIVE GREEN

## BROWN



RAL 8017 CHOCOLATE BROWN

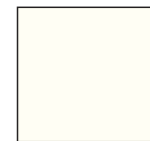

RAL 9010 PURE WHITE



RAL 9016 TRAFFIC WHITE

## REDS & ORANGE



RAL 3002 CARMINE RED



RAL 3004 PURPLE RED



RAL 3007 BLACK RED



RAL 3015 LIGHT PINK



RAL 3016 CORAL RED



RAL 3027 RASPBERRY RED



RAL 4004 CLARET VIOLET



RAL 2011 DEEP ORANGE

## GREYS



RAL 7006 BEIGE GREY



RAL 7012 BASALT GREY



RAL 7015 SLATE GREY



RAL 7016 ANTHRACITE GREY



RAL 7026 GRANITE GREY



RAL 7030 STONE GREY



RAL 7040 WINDOW GREY

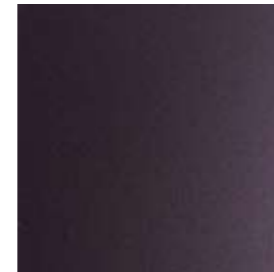

FOPP

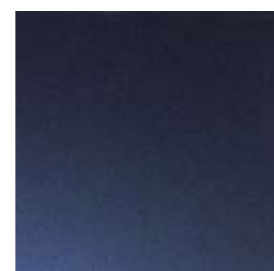

MAGGIE

## HOW TO CLEAN YOUR ESKIMO RADIATOR SURFACE

Beauty is in the eye of the beholder.

Some like to maintain their beauty, some see the beauty in the natural ageing over time. One thing's for sure, Eskimo's radiators are all beautiful.

### Outline radiators

#### Brushed

Clean with a stainless steel cleaner, no abrasives, then rub down with baby oil along the grain for a smear-free sheen.

RAL colour finish (inc. metallics: Maggie, Fop, Compost and the NEW sublimation prints)  
Any multisurface cleaner suitable for kitchen worktops but no abrasives.

#### Supermirror and Brassy

Any glass cleaner suitable for use on mirrors. If you suffer any particularly bad staining or tarnishing, try gently buffing with Brasso.

#### Concrete & Marbles

Use water or any multisurface cleaner with a lint free cloth or soft brush.

#### Woody & Bamboo

Woody's Oak veneers are lacquered so we suggest a spray furniture polish.

#### Gong

It is not recommended that you try to clean or add anything to the patinated surface.

It should not be necessary to have to clean the surface. At most, a yellow duster or soft muslin cloth can be used to polish. Spillages or anything of

that sort should be removed immediately with soft tissue. All standard cleaning products are a bad idea as they will, at best, attack the wax, at worst, damage the patina.

If cleaning is really necessary, the radiator should be allowed to cool and then a very dilute sugar soap solution can be used with soft muslin and then dried thoroughly with tissue.

No abrasives should be used or applied and you should not attempt to wax the radiator.

#### Rusty

As Gong, above.

### RON radiators

#### Gold finish

Gently clean with soapy water and then buff with a dry lint free cloth.

#### Matt aluminium finish

Gently clean with soapy water and then buff with a dry lint free cloth.

RAL colour finish (including three metallics: Maggie, Fop, Compost & sublimation prints)  
Any multisurface cleaner suitable for kitchen worktops but no abrasives.

#### Polished finish

Any mirror cleaner. Use Brasso for stains.





## VENTING PROCEDURE

Before balancing, make sure that the radiators have been vented (bled). Recommended Venting Procedure for water radiators (with bottom opposite end connections).

Please ensure that you have a container and cloth at the ready to catch any water that may be lost during the following process, and the central heating system is turned off.

For best results vent the system when cool. Generally radiators will have been 'balanced' by the setting of the return-side valve. If this is the case, record the setting (e.g. The number of turns it takes to close, or the position of slot on the 'ball valve' type) and return to this setting after completing the following procedures:

**Sealed Systems**  
(e.g. Combi-boiler)  
Radiators installed on 'pressurized' systems are under simultaneous pressure on their flow and their return sides. This may sometimes cause a stubborn airlock in the middle of a radiator.

The following process promotes natural water gravitation and easier venting by using system pressure separately on the flow and return side of a radiator.

1. Carry out an initial vent from all radiators, working from the lowest point upward, retopping pressure frequently to maintain approximately 2 bar throughout the venting process.

2. Run central heating system for 5 minutes, switch off and allow it to cool completely.

3. Carry out a full and thorough vent from the entire central heating system, as before.

4. Return to the radiator to be vented and close the flow valve and return valve.

5. Vent radiator, ensuring all pressure is released from radiator water first, air last.

6. Gently open the return valve only (with the vent closed) and then close again.

7. Vent radiator ensuring all pressure is released from radiator water first, air last.

8. Repeat steps 5 & 6 until all air is removed (maintaining 2 bar pressure).

9. Open the flow valve.

10. Return the return valve to the noted position.  
**Open Systems** (e.g. with an expansion tank in the loft)  
The following process promotes natural water gravitation and easier venting by using system headerpressure on the return side of a radiator.

1. Carry out an initial vent from all radiators, working from the lowest point upwards.

2. Run central heating system for 5 minutes, switch off and allow it to cool completely.

3. Carry out a full and thorough vent from the entire central heating system as before.

4. Return to the radiator to be vented and close the flow valve.

5. Open the return valve fully.

6. Vent radiator slowly and repeatedly until all air is removed.

7. Open the flow valve.

8. Return the return valve to the noted position.

## AIR/GAS IN WATER RADIATORS

All air should be removed from the system before normal operation.

Once a heating system has been installed, it should be chemically cleansed and inhibited according to British Standard BS7593: 1992.

All air should be removed from the system before normal operation. Although radiators may be vented (i.e. air bled out) on an annual basis as a matter of routine maintenance, the need for more frequent venting may indicate a system problem.

The presence of air, or gases (the by-product of corrosion), in a central heating system can be identified by:

- Cold spots in radiators (generally at the top).
- 'Trickling' or 'bubbling' sounds from radiators (particularly column type radiators).
- Pin hole corrosion in radiators.

These symptoms can generally be eliminated by:

- Fully venting all air out of the system.
- Ensuring there are no leaks anywhere in the system.
- Chemically cleansing and inhibiting the system.

• Ensuring that no radiator is above an air separator or system vent position (open system only).

Failure to eliminate all air or gas from a radiator, or the re-occurrence of gas in a radiator, may be attributed to one or more of the following reasons:

- Air remaining in the system, which has not been released through venting, which may then travel around the system.
- The central heating system has an intake of air, which is then being circulated around the system, and is collecting in the radiator(s). (Micro leaks often occur at screwed or compression joints on the suction side of the pump and can allow air in without letting water out.)
- The central heating system has not been inhibited, or is insufficiently inhibited, allowing the continuous production of hydrogen gas, which is subsequently being pumped around the system and is collecting in the radiator. (Hydrogen is a byproduct of electrolytic corrosion and is often mistaken for air. Due care must be taken as hydrogen is highly combustible.)

• The pump for the central heating system is set too high, causing the release of oxygen from the system's water ('cavitation'), which is then being pumped around the system and is collecting in the radiator(s).

• The pump for the central heating system is incorrectly positioned in relation to the feed and expansion pipes, causing the production of oxygen ('pumping over'), which is then being pumped around the system and is collecting in the radiator (only applicable to open vented systems).

• The central heating system's air vent has been installed below the top of said radiator, consequently causing air to rise to the highest level and collect within.

**Maintenance**  
A poorly maintained or untreated system will work to the detriment of all its components, dramatically shortening their longevity, so please ensure that your central heating system contains non-corrosive, clean water, and has the correct amount and type of corrosion inhibitor applied - in accordance with British Standard 7593:1992. (This is

also essential for central heating systems which are supplied via a water-softener.)

If the system contains unclean water, or does not have an inhibitor applied it may be advisable to seek advice from a qualified plumber or heating engineer on chemically cleansing and flushing the entire central heating system (including the boiler) in accordance with British Standard 7539:1992, and with the manufacturer's instructions.



## RADIATOR BALANCING

Before balancing, make sure that the radiators have been vented (bled). If a system is not properly balanced it will result in one or more radiators not heating up properly, or not heating up at all.

Balancing may be necessary any time radiators are fitted in an existing system or upon the installation of an entire heating system.

A basic explanation of what balancing involves is helped by an understanding of the way water behaves when flowing through any pipe-work system and what is meant by pressure drop.

### Pressure Drop

This describes the effect of friction on the water flowing through pipes – the resistance to the flow of the water. This resistance is increased by twists and turns and will be higher in a smaller diameter pipe than it will be in a larger one. It's also increased every time the water flows from a pipe of one diameter to a pipe of a different diameter or through a valve. Pressure drop is measured in Bar or PSI and essentially the water pump has to generate enough pressure to overcome the total pressure drop (can also be called pressure loss) in the system.

Every radiator will have a different pressure drop. Combine this with the fact that the pipes flowing to and from each radiator will be of different lengths and take straighter, or

more circuitous routes, and you'll see that the water will have to work harder to flow round some radiators in your system than others.

### Lazy water

The water flowing around your system is essentially lazy. It will follow the path of least resistance. If radiator A and its associated pipe-work has a lower pressure drop than radiator B, then more of the water will flow to radiator A. If the pressure drop through radiator B and its pipes are much higher than radiator A then it won't bother going through radiator B at all.

Balancing is the name for the procedure that ensures that each radiator in the system has a roughly equal pressure drop and is done by using the lockshield valve on the return side of the radiator (the downstream side).

### Valves

The lockshield valve is on the other end to the thermostatic valve and usually requires a screwdriver, spanner or allen key to operate it, although sometimes they can be turned by hand.

If thermostatic valves (TRVs) are not being used, i.e. your valves are manual on/off valves then use the valve on the return side of the radiator (if in doubt as to which this is check with your plumber – it will be the cooler of the two pipes if you can feel a difference, or the pipe which heats up last when the heating is first switched on)

In principle balancing involves using the lockshield valve to restrict the flow of water (thereby increasing the pressure drop) through those radiators that have a lower pressure drop while leaving the lockshield valve open on those radiators with a higher pressure drop to make it as hard for the water to flow through radiator A as it is through radiators B, C, D etc.

In practice it can mean tightening (clockwise) or loosening (anticlockwise) each valve a little at a time until the pressure drop at each of the radiators is equal – balanced.

### Radiator Thermometers

The job of balancing a system is made much easier with the use of radiator thermometers – these measure the temperature drop across the radiator and allow you to ensure that there is an equal temperature drop

across each radiator, meaning that each radiator is receiving the required flow of water.

This temperature drop will usually be something between 10°C and 20°C depending on your system – if in doubt go for 12°C – the key is to ensure that the temperature drop is the same across each rad.

### Balancing Procedure

1. Before you start balancing it's important to make sure that the radiators have been vented (bled) properly so that all the air in the radiators is removed – if in doubt see Eskimo technical help file “venting procedure”.

2. Start by switching off the system and letting the water cool down.

3. Remove any cover from the lockshield valve(s) and find the appropriate tool(s) for adjusting it (them).

4. Open both the lockshield valve and thermostatic valve (or the other manual valve - normally positioned at the opposite end of the radiator) on ALL radiators.

5. With all the radiator valves now fully open, switch on the central heating system - if all the radiators become similarly hot in a similar time there is nothing to do and your radiator balancing is completed. If not, and “not” is usually the case, then follow the procedure below:

If not using radiator thermometers  
6. Allow the system to cool down, then with all valves still fully open – switch it on again. Find the radiators which get hottest quickest and restrict the

flow through them by turning down the lockshield valves (clockwise). There is no fixed order in which to restrict radiator valves except to do the hotter radiators first. This pushes more flow through the remaining radiators. Work out how many turns it takes to fully close the lockshield valve and then return it to about 50 or 60% closed (i.e. if it takes 5 turns to close it fully, turn it 2.5 or 3 turns).

7. Having restricted the return valves on the hottest radiators by 50% or 60% to start with, wait to see what happens.

Cooler radiators will start to get hotter. Some previously cool radiators may get fully hot. If some are still cool go round again, restricting all the hotter radiators by turning down the lockshield valve (clockwise again), some which were restricted before should be closed down even more (always on the lockshield end) and some which weren't restricted first time round should be restricted this time because they are now hot.

Again wait to see what effect this has and again, if necessary, further restrict the hotter radiators. Continue until all of the

radiators are roughly equally hot and have roughly the same temperature drop across the pipes.

If using radiator thermometers  
8. Fit the radiator thermometers to the INLET and OUTLET pipes of the nearest radiator to the boiler. DO NOT fit them to the main flow and return pipes.

9. Switch on the central heating system.

10. Close the lockshield valve on the first radiator to almost closed, as the temperature of the systems comes up, gradually open up the valve until the temperature difference between the two thermometers is about 12°C.

11. Move the thermometers to the next radiator away from the boiler. Close down the lockshield valve and adjust it until the temperature difference increases to about 12°C (the temperature difference will probably start at less than 12 degrees with both valves fully open).

12. Work along the rest of the radiators until they have all been balanced.



## DELTA T

Delta T ( $\Delta t$ ) is the difference between the desired ambient air temperature in the room (if in doubt use 20°C) and the mean water temperature in the radiator. To calculate the mean water temperature in the radiator, add the water temperature at the inlet to the radiator to the water temperature at the outlet from the radiator and divide by 2. As an example:

You wish to have an ambient air temperature of 21°C in your bathroom. The water coming in to the radiator is at 50°C, by the time it's passed through the radiator it is down to 42°C. The mean water temperature is therefore  $(50+42)/2 = 46^\circ\text{C}$ . To calculate the Delta T, subtract 21 from 46; the Delta T is therefore 25°C. A Delta T of 60°C is shown in the price lists. If your Delta T is not 60°C then you will need to apply a correction factor to the heat outputs shown in the price lists - see the list of correction factors alongside.

The boring bit:  
ALL SALES AND TECHNICAL INFORMATION MAY BE SUBJECT TO CHANGE WITHOUT NOTICE AND IS SUBJECT TO ESKIMO'S STANDARD TERMS AND CONDITIONS, COPIES OF WHICH ARE AVAILABLE ON THE WEBSITE  
[www.eskimoheat.com.au](http://www.eskimoheat.com.au)

$\Delta t$ °C	Correction Factor
20	0.24
21	0.26
22	0.27
23	0.29
24	0.30
25	0.32
26	0.34
27	0.35
28	0.37
29	0.39
30	0.41
31	0.42
32	0.44
33	0.46
34	0.48
35	0.50
36	0.51
37	0.53
38	0.55
39	0.57
40	0.59
41	0.61
42	0.63
43	0.65
44	0.67
45	0.69
46	0.71
47	0.73
48	0.75
49	0.77
50	0.79
51	0.81
52	0.83
53	0.85

$\Delta t$ °C	Correction Factor
54	0.87
54.5	0.88
55	0.89
55.5	0.90
56	0.91
56.5	0.92
57	0.94
57.5	0.95
58	0.96
58.5	0.97
59	0.98
59.5	0.99
60	1.00
60.5	1.01
61	1.02
62	1.04
63	1.07
64	1.09
65	1.11
66	1.13
67	1.15
68	1.18
69	1.20
70	1.22
71	1.24
72	1.27
73	1.29
74	1.31
75	1.34
76	1.36
77	1.38
78	1.41
79	1.43
80	1.45

## NON STANDARD CONNECTION POSITIONS

Both Outline and Ron radiators can be specified with alternative connection positions at an additional cost – please contact Eskimo for details: 0207 117 0110, [sales@eskimodesign.co.uk](mailto:sales@eskimodesign.co.uk)

As Standard, Outline radiators use positions B & C. To specify the connection positions in the part number, follow this example for a Get Up 2000mm high x 430mm wide x 95mm deep in brushed stainless, with one connection on the top right hand face and one on the bottom left hand side face.

**43200D-B-AY**

All connections positions are 33mm in from the corner of the radiator. Inlet and outlet do not have to be specified.  
**NOTE: You cannot specify both connections on one corner i.e. connection positions AB or VX etc.**

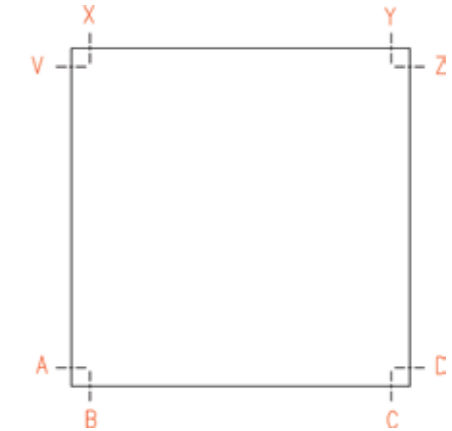

As standard, Ron radiators use positions A & D. Other connection positions can be specified as shown.

To specify the connection positions in the part number follow this example for a Ron 1800mm high x 416mm wide in polished aluminium with one connection on the right hand face at the side and one on the bottom left hand face.

**RON-18-416-P-AZ**

Inlet and outlet do not have to be specified.  
**NOTE: You cannot specify both connections on one corner i.e. connection positions AB or CD.**

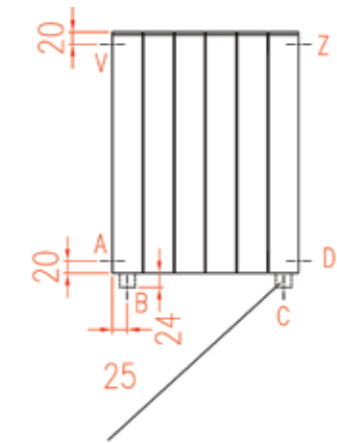





**GLOW CITY**

**352 Morphett Road  
Warradale SA 5046  
8397 6100**

**GLOW SOUTH COAST**

**16 Wright Road  
Goolwa SA 5214  
8554 2860**

**info@glowhce.com.au | glowhce.com.au**



T 1300 544 719 | E hello@eskimoheat.com.au  
www.eskimoheat.com.au